

# SAGLAM METAL

## BRONZE & COPPER FOUNDRY

- \* Casting
- \* Forging
- \* Rolling +
- \* Ring Rolling

Just because there's tarnish on the copper,  
doesn't mean there's not a shine beneath.

Laurence YEP

# SAGLAM METAL With Figures

**1997**

Start: Distribution of Special Steels and Copper Alloys

**2005**

Production of Copper and Copper Alloys

**2007**

Joint Venture (Dörrenberg Edelstahl Germany)

**4**

Plants

Copper ——— Heat Treatment  
 ———  
 ———  
 Bronzes ——— Recycling  
 260 Employees (37 Engineers)

**3**

Foreign Companies

- ITALY (Le Cuivre Srl.)
- USA (Tough Copper Alloys)
- ROMANIA (Fine Metal Srl.)

**2**

Warehouses

↙ ↘  
 Copper Alloys      Special Steels

**PUBLISHING HOUSE**

Books for Metals

**SOLAR POWER STATIONS**

1.5 Megawatt

**R&D CENTER**

- Patents
- Copyrights
- Articles

**ONLINE SALES**

- Online support
- Easy offer
- Quick order
- Quick delivery

**MACHINERY**

7 Induction Furnaces  
 4 Centrifugal Casting  
 3 Continuous Casting

4 Forging Presses  
 3 Heat Treatment Furnaces  
 2 Fine Cutting

Foundry + Forming

51 Sawing Machines  
 12 CNC Machines  
 10 Lathes Machines

3 Milling Machines  
 2 Bohrwerks

Machining

# SAGLA METAL



**BALIKESİR  
PLANT**



**GEBZE  
PLANT**



**Induction Furnace**

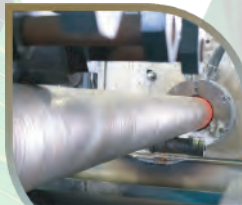

**Continuous Casting**



**Centrifugal Casting**



**Forging Press**



**Ring Rolling**



**Forging**



**CNC Machining**

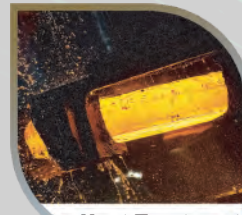

**Heat Treatment**



**R&D Center**

## Quality Management

Producing the right products needs research, right processes, right raw materials and focussing on quality. We believe that following on quality will pay off in the long term due to giving our best to our customers. S.M conducts various tests in house. Here's our control equipments:

- Optical Emission Spectrometer,
- Electrical Conductivity Test
- Ultrasonic Test
- Metallographic Test
- Surface Roughness Test
- 3D Dimensional Control (CMM)
- XRF
- Hardness Test
- Liquid and Fluorescent Penetrant Test
- Corrosion Test
- Microhardness Test
- Tensile Test

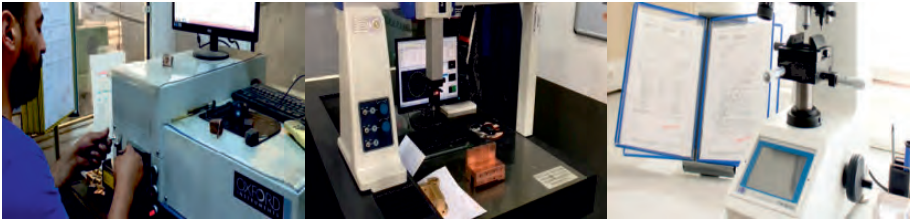

## Standards

We produce / test / certify our products according to EN, AMS, BS, I.S.O. and ASTM standards. In case of specific requirement please ask to our sales or quality team.

## Research and Development

At Saglam, having a R&D department gives us the possibility to develop new materials and process development, assisting us in remaining highly competitive. We also academically cooperate with different departments of technical universities. Excellent quality by producing special copper alloys and steels according to our customers demand.

Excellent quality would never be without certificates:

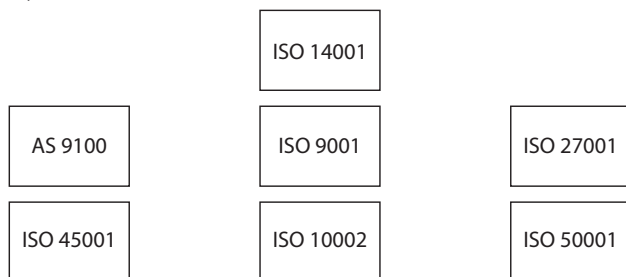

Integrated Quality Management System



## Logistics

Our main customers are based in Europe but we do supply also to overseas countries by air or by sea transportation.



Fleet of Sağlam Metal

Having four trucks of Fine Metal Srl. always on the way to European countries and Türkiye, enable us to export our products easily due to easy transportation. These trucks can also carry our customer goods in these destinations. Sağlam's own fleet which consist of three trucks and five middle size trucks gives us the possibility of delivering their orders to customers in door and taking their scraps on return to our foundry.

## Distribution Net

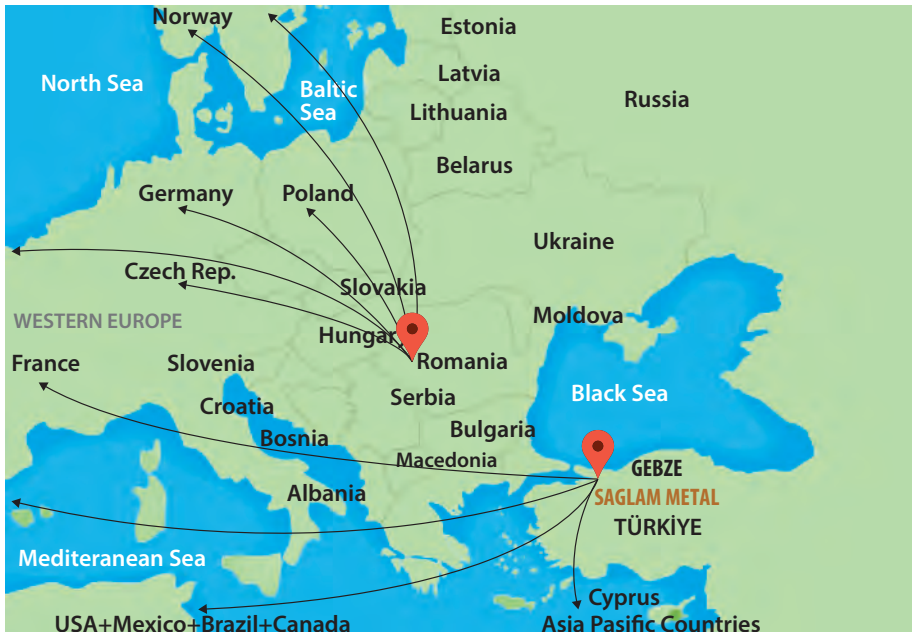

# 1- PRODUCTS

## 1- Pure and Hard Copper Alloys

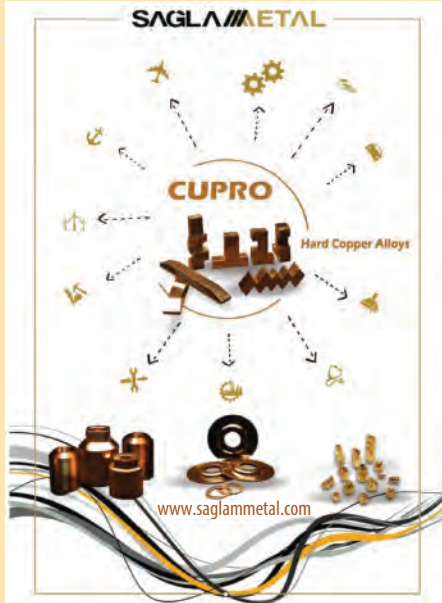

Almost of twenty years manufacturing copper and copper alloys has allowed Saglam Metal to have great skills and a wide know-how in processing these alloys.

Copper industry has invested a lot research activities over the years just to create new copper alloys which capable of meeting new demands coming with new technologies. The seexcellent materials' properties and the wide variety of alloys range, sizes and supply conditions, enable Saglam to be a strategic partner, which can meet the specific needs of production and performance of its customers.

Saglam can offer more than 25 different copper alloys, excluding the pure copper grades. When Saglam conducts its production ability with recycling of copper scraps and transportation of them, then the reasons behind the success might be seen more clearly.

Pure copper alloys we can produce are listed in following table.

Material		Electrical Properties			
Copper Grade	Code (E.N)	Massive Resistivity	Volume Resistivity	Nominal Conductivity MS/m min.	%ACS min.
<b>Cu-ETP</b>	CR003A	0.15328	0.01724	58.00	100.0
<b>Cu-OF</b>	CR008A	0.15328	0.01724	58.00	102.0
<b>Cu-HCP</b>	CR021A	0.15596	0.01724	57.00	98.3
<b>CuAg<sub>0,04</sub></b>	CR011A	0.15328	0.01724	58.00	100.0



With our own solar power stations and our special contract with our electricity supplier we are using 100% "Green Energy" in our production.

## Hard Copper Alloys

Hard Copper Alloys	Applications	Hardness
<b>1) Cupro MAX</b> 1.0 Cr, 0.10 Zr, Cu	Welding electrodes and discs of low carbon steels and galvanised sheets, EDM electrodes, casting moulds of non-ferrous metals, blasting nozzles of plastic injection machines.	135-170
<b>2) Cupro CNB</b> 0.50 Be, 2.0 (Co+Ni), Cu	It is used as spot welding electrodes of stainless steels, monel and nickel alloys, in plastic injection moulds, casting moulds of non-ferrous metals, welding electrodes in wire mesh production. It has more lifetime than Cupro NSS. in low alloy die casting plunger tips.	220-260
<b>3) Cupro NSH</b> 3.0 Ni, 0.9 Si, 0.45 Cr, Cu	Developed by SM, R&D center. Produced as an alternative to Cupro CNB (Be and Nickel alloy). It can replace Cupro CNB in all applications. Higher wear resistance	220-240
<b>4) Cupro B2</b> 2.0 Be, 0.50 (Co+Ni), Cu	It is the hardest beryllium copper. Its hardness is close to steel (37-41 HRC). Main applications are plastic moulds inserts, butt welding electrodes and non-sparking tools.	340-390
<b>5) Cupro NSS</b> 2.4 Ni, 0.70 Si, 0.40 Cr, Cu	It is a nickel and silicon containing alloy. It is also known as piston copper since it is especially used in piston tips of low alloy die-casting machines. Other applications are connection parts of high speed trains catenary parts.	180-220
<b>6) Cupro NSM</b> 7.0 Ni, 2.0 Si, 1.0 Cr, Cu	It is preferred as alternative to beryllium copper in plastic moulds. It has a good thermal conductivity, hardness and mechanical properties. It is used as cooling inserts in casting moulds and plastic moulds. It is an alloy developed by Saglam Metal.	280-320

## Several Standards of CuBe2 Alloy

<b>C17200</b> (Beryllium Copper)	<p><b>CuBe2 (Solid &amp; Hollow Bars / Plate)</b></p> <p>These copper alloys have higher mechanical properties compared to the other copper alloys. These alloys have excellent abrasion and corrosion resistant properties. Therefore these alloys have excellent bearing qualities with extremely high wear resistance.</p>
<b>AMS 4533</b> (Beryllium Copper)	
<b>ASTM B196</b> (Beryllium Copper)	
<b>QQ-C-530</b> (Beryllium Copper)	
<b>AMS 4534</b> (Beryllium Copper)	
<b>AMS 4535</b> (Beryllium Copper)	
<b>AMS 4650</b> (Beryllium Copper)	

# APPLICATIONS

## 1. Resistance Welding

### a. Seam Welding Discs

Main application fields of seam welding are

- Panel radiator production
- Barrel production
- Can welding
- Sink welding
- Gas tank welding
- Tubes

Stock sizes in Cupro MAX and Cupro CNB are:

- dia.250x16 mm
- dia.250x20 mm
- dia.300x16 mm
- dia.300x20 mm
- dia.400x18 mm



**FORGED!**



## b. Spot Welding Electrodes

This welding process is used primarily for welding two or more mainly mild steel sheets together by applying pressure and heat from an electric current to the weld area.

**Available sizes of our raw material for producing electrodes:**

Dias 10, 12, 14, 15, 16, 18, 20, 22, 25, 28, 30, 35, 41, 46, 51, 56, 61... 101 mm

Flats: 300x10, x 15, x 21, x 26, x 31, x 41, x 51, x 61 mm



### c. Flash Butt Welding

It's a type of resistance welding that does not require filler metals. It is generally used for welding thick workpieces like anchor chain, rails and pipes.

In flash butt welding; due to high hardness and mechanical properties are needed, Cupro CNB and Cupro B2 grades can be used.



**FORGED!**

#### d. Wire Mesh Welding

Products for wire mesh welding:

- Electrodes
- Electrode holders

##### 1. Electrodes

Strength of our electrodes is coming from special cold drawing process.

SAGLAM METAL offers high strength CuCoNiBe (min. 240 HB),

- 20x20 mm
- 30x30 mm
- 35x35 mm
- 38x38 mm
- 40x30 mm
- 50x50 mm
- 50x40 mm
- 20x25 mm (profile 13946)
- 18x45 mm (profile 14717)
- Ø40 mm
- Hex.40 mm
- Oct.40 mm

We are able to produce your special sizes as well!

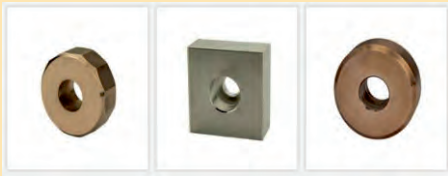

##### 2. Electrode holders

Electrode holders are used for transmitting current from power supply to electrode.

It needs to be the best combination of hardness and electrical conductivity. What we offer for this application is **Cupro CNB, Cupro MAX** and **Cu-ETP**. Thanks to our 12 CNC machines, we are able to produce ready-to-use parts according to your technical drawing. For better electrical conductivity, we have the possibility of silver plating

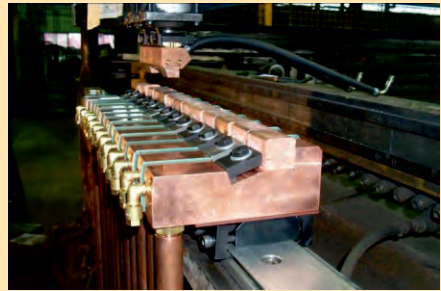

**FORGED+**  
**Colddrawn**

## Mould Making

### a. Permanent Moulds (Metallic Moulds)

Permanent Mould Casting is a method of casting liquid metals into a metal mould. Hard copper alloys such as **Cupro CB**, **Cupro CNB**, **Cupro NSS** and **Cupro MAX** give very good results in permanent mould casting of aluminium and copper alloys.

	Casting metal	Main group	Machine type		Copper alloy
Light Metals	Aluminium and its alloys	Injection	Cold chamber		Cupro CB Cupro CNB Cupro NSS
	Magnesium and its alloys	Injection	Injection		Cupro CB Cupro CNB Cupro NSS
Heavy Metals	Brass	Hand casting	-	Hand casting Permanent moulds	Cupromax Cupro CB Cupro NSS Cupro Cupro CNB
		Low pressure	-	Machine casting Permanent moulds	Cupro CB Cupro CNB Cupro NSS
		Injection	Cold chamber		Cupro CB Cupro CNB Cupro NSS

The table above demonstrates the types of hard copper alloys that can be used in moulds for casting non-ferrous metals.

Brass, which is increasingly used in the sanitary system industry, is cast either by handmade or by permanent mold casting machine. Their moulds can also be made from **Cupro CB**.

The high thermal conductivity and hardness of beryllium copper alloys like **Cupro CB** makes ideal material in this application. Battery faucets moulds, watermeter moulds, faucet moulds are made of this material.



## b. Plastic Moulds

Hard copper alloys are used in three different plastic moulds:

- 1- Injection moulds
- 2- Blow moulding
- 3- Thermoform moulds.

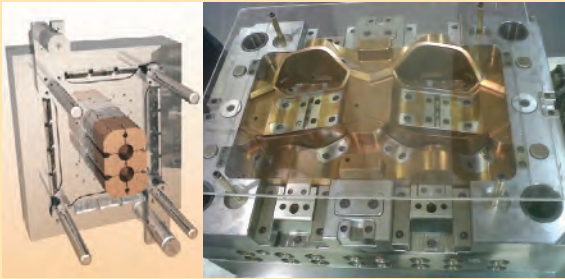

Due to high thermal conductivity copper alloys especially preferred on such moulds. Low cycle time brings time saving and cost saving. **Cupro CB, CNB, NS, NSM and B2** are most used grades of hard copper alloys. For this application.

## c. EDM Electrodes

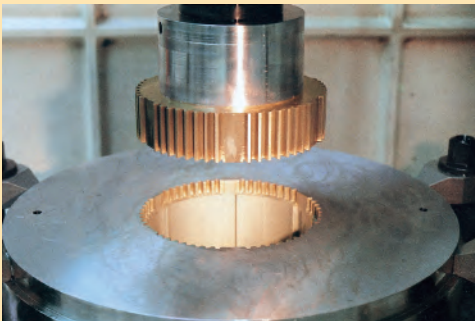

EDM is a process of forming the surface of metallic materials. Thanks to this process; all the materials that are conductive can be formed. Especially in hardened steels and hard materials where conventional machining is very difficult to machine because of their high hardness hard copper alloys like **Cupro MAX** can be used as electrode due to its high electrical conductivity.



## Injection Casting

Cupro CB, Cupro CNB or Cupro NSS alloys give very good results for the pistons used in injection machines which are working with cold chamber method of aluminium and magnesium alloys.



Complex shaped low weight alloys, especially for automotive industry, like aluminium, zinc, zamac, etc. are best produced by pressure die casting method. In order to reduce unit cycle time and better durability, piston tips are preferred as forged hard copper alloy. All technical drawings can be machined by our machining department.

## Dam Blocks

Continuous casting is the process whereby liquid metal is solidified into a semifinished size. Majority of the world's continuous cast copper rod is produced by wheel-belt or twin-belt casters. The casting machines use copper alloy components including casting wheels and dam blocks as cooling parts. Saglam produces these blocks in Cupro CB, Cupro CNB or Cupro NSS grades.

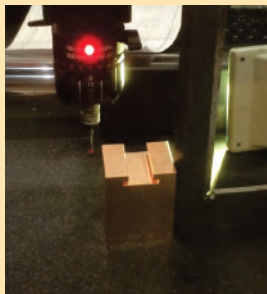
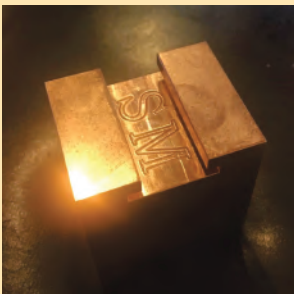

## Energy

### Railway Catenary Systems:

A catenary is a system of overhead wires used to supply electricity to a locomotive, streetcar, or light rail vehicle. In this system there are some parts like connection clamps and terminals which are under high pressure and friction. They have to be produced by copper and copper alloys. Our brand name **Cupro NSS (CuNi2Si)** is preferred in catenary systems of High Speed Trains and light rail systems because of perfect combination of electrical conductivity and mechanical properties.

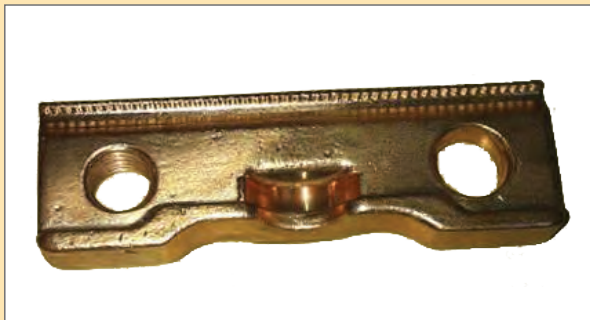

## Short Circuit Rings

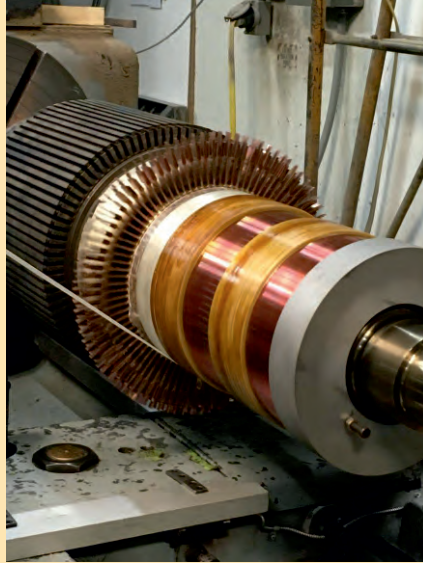
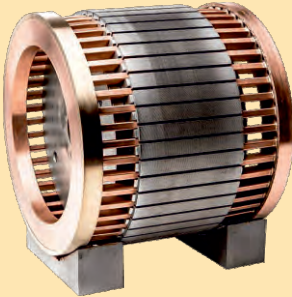
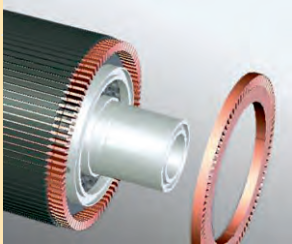

Saglam offers seamlessly rolled and forged copper rings for industry. Our copper and copper alloys with high quality and short delivery times attracts new customers.

Produced by a modern ring-rolling machine to a near net shape, our seamlessly rolled rings maximum size range is;

Ø 950 mm, **Length:** 340 mm

Seamlessly rolled and forged rings in

- Cu-ETP
- Cu-HCP
- CuCr1Zr
- CuNi2Si

Small orders from 2 to 10 rings and big orders, rings in rough machined condition and finish machined condition, destructive and non-destructive testing possibility

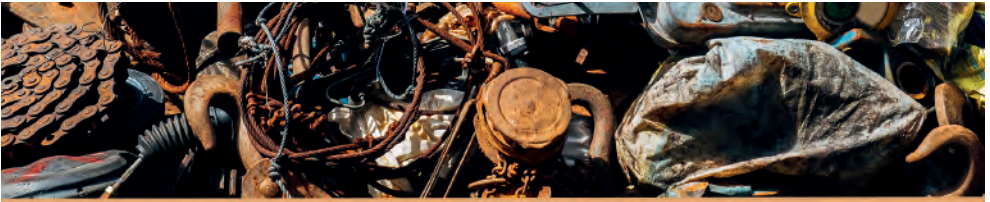

# SCRAPS CHIPS

Metal Recycling

C  
O  
P  
P  
E  
R

S  
T  
E  
E  
L



[www.saglammetal.com](http://www.saglammetal.com)

**SAGLAM**  **METAL**



# SUSTAINABILITY



## Economic and Financial Measures

- Revenue and cost
- Efficiency and productivity
- Organisational size and value
- Company growth
- Employment distribution by sector
- Percentage of firms in each sector
- Revenue by sector
- Profit margin

## Environmental Measures

- Air and water quality
- Energy consumption
- Natural resources
- Solid and toxic waste
- Land use and land cover

## Social Measures

- Quality of life
- Unemployment rate
- Gender equality
- Income
- Relative poverty
- Higher education
- Average commute time
- Crime
- Life expectancy

## Sustainability Parameters of Saglam Metal

- Environment, Climate and Energy Efficiency
- Employee Rights, Employee Development,
- Employee Engagement
- Social Equality of Opportunity and Diversity
- Water Management
- Waste Management and Recycling
- Business Ethics & Anti-Corruption
- Innovation, R&D and Digitalization
- Safe-Green-Economic Transportation
- Social responsibility
- Corporate Transparent Management
- Customer Satisfaction and Quality Management

**SAGLAM METAL**



## 2- ALUMINIUM BRONZES

Aluminium bronze is a type of bronze that contains aluminium up to 14% as major alloying element. It provides excellent mechanical and physical properties which other bronzes can not. Some aluminium bronzes, that we called hard aluminium bronze, can reach up to 42 HRC. Other alloying elements like nickel, iron and manganese effect mechanical behavior of these bronzes.

The aluminium bronzes are a family of copper-based alloys offering a combination of mechanical and chemical properties unmatched by any other alloy series. This feature often makes aluminium bronzes the first choice and sometimes the only logical choice for demanding applications.



Thanks to its corrosion resistance and machinability; it is used in marine industry and aviation industry where corrosion resistance is much preferable.

Aluminium bronzes have many application fields in several industries like; machine building, aviation, marine, iron and steel, energy, oil and gas, food and medicine, etc.

Hard aluminium bronzes are generally used for forming metals. Because of its high hardness and very smooth surface quality; it is the best choice for forming rather than tool steels.

## Standard Aluminium Bronzes

Cupral 1 9.0 Al, 1.0 Fe, Cu	Cupral1 and Cupral2 are the most similar aluminium bronzes to tin bronzes with their low hardness property. With their low density, they provide additional advantages with higher wear resistance and sliding properties compared to tin bronzes. They are used in bearings, bushes, gears and sledges manufacturing. Besides, with their ductility feature this materials are used in the food industry.	115-150
Cupral 2 10.0 Al, 3.0 Fe, 1.0 Mn, Cu		130-180
Cupral 4 13.0 Al, 4.0 Fe, 2.0 Mn, Cu	It is a hard material with very good sliding properties. Its wear resistance is high. Can be used as wear parts, wearresistant slides, bending tools, pipe end holding jaws, tapered wedges, construction of ushing or core in plastic mold manufacturing.	270-320
Cupral 4M 10.0 Al, 5.0 Ni, 4.0 Fe, Cu	It is a bronze with 5% nickel addition, whose mechanical properties at high temperatures are balanced with its corrosion resistance. In pipe manufacturing; used in bending and straightening tools (spoons and mandrel), wear resistant machine parts, press bushings, all kinds of sledges, propellers and gear production. It is shown in various standards as C63000, CW307G and 2.0966.	180-230
Cupral 5M 10.0 Al, 5.0 Ni, 4.0 Fe, Cu	It is a special bronze alloy that combines very high tensile, yield strength and hardness with toughness. With a special heat treatment applied to Cupral4M, it reaches superior mechanical properties and maintains its properties at high temperatures. It has high sliding property.	260-320
CupTin 8,10,12.0 Sn, Cu	It is in the bronze group containing around 8, 10, 12, 14% tin. It is preferred in bearings with pressurized loads thanks to its superior lubrication property. However, with the increasing use of alternative materials such as Cupral 4M which offers lighter and better wear resistance, it is getting less preferred.	70-120

## Special Aluminium Bronzes

QQ-C-645B	Solid & Hollow Bars / Plate These special bronzes have high strength and toughness in addition these alloys resistance to oxidation and corrosion. They are used extensively for aircraft landing gear bushings, bearings, other military and aircraft components. Containing 5% nickel provides extra high mechanical properties.	180-200
ASTM B150 (Nickel Aluminium Bronze)		180-200
C63000 (AMS 4640) (Nickel Aluminium Bronze)		201-248
C63020 (AMS 4590) (Nickel Aluminium Bronze)		212-268
C95400 (ASTM B148/B505) (Aluminium Bronze)		150-170
C95510 (AMS 4880) (Nickel Aluminium Bronze)		200-240
C95520 (AMS 4881) (Nickel Aluminium Bronze)		212-268

## Hard Aluminium Bronzes

Cupral 8 14.0 Al, 5.0 Fe, 2.2 Mn, 1.0 Co, Cu	It is a very hard material with good sliding properties. It has high wear resistance and compressive strength. It is the most preferred bronze in deep drawing moulds of stainless steel sheets. Also in pipe manufacturing; it is used in machine parts that require abrasion resistance such as bending mandrels, welding and forming rolls.	350-375
Cupral 10 14.0 Al, 5.0 Fe, 2.2 Mn, Cu	It is an extremely hard aluminum bronze. It is sliding property is good. It has resistance against high pressure and abrasion. It is very brittle material, it must be machined carefully. Cupral 8 is more preferred due to the brittleness of this material and the difficulty of machining. Application fields are the same.	380-410

# APPLICATIONS

## 1. Machinery

### 1.1 Gear Manufacturing

In gear applications and heavy load guides Aluminium Bronzes are used as sacrificial components and heavy in which other materials would fail quickly. They are developed for heavy loads, shocks and harsh working environments and so are found in steel Works, in mining and earth moving equipments. When it is seen that lubrication of sliding surfaces is less than normal, aluminium bronzes are more preferable than ferrous materials for gears. Wrought and cast alloys both can be used for the gears. Casting and an additional forging operation provides excellent properties for the gear.

Bronzes have enough strength to withstand to highloads of gears and also a low friction coefficient against steel. A worm gear is a mechanical element consists of a helzeonic threaded shaft butted against a toothed Wheel, resembling a standard gear. Worm gears are more and more commonly used because of their high gear reduction ratios. This advantage makes worm gears ideal for applications that require reduced speeds and increased torque.

Saglam has been supplying Nickel Aluminium Bronze of **Cupral 4M** to gear manufacturers mainly. Our full production capabilities enable us to keep "blank bronze gears" in stock too. We can machine our bronzes into slightly over sized blanks. This brings opportunity to our customer to save time by only doing the final machining processes. This also lowers scrapp and saves rough machining time.

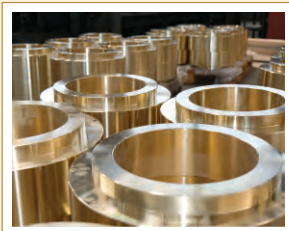

## 1.2 Bushings / Sleeves

Bushings can be made of a wide variety of materials. But bronzes are the key materials for heavy loads. The bushing material must support and protect the component from damage.

It's important to know that a shaft isn't exactly centered inside the bushing during rotation. This distance is known as eccentricity and provides clearance for lubrication.

Aluminium bronzes are the strongest and most complex of the copper based bearing alloys. Their high strength and low friction coefficient makes idealistic materials for bearing bronzes. This principal is also important for bronze sleeve bearing applications which are designed to protect a steel shaft.

Aluminium Bronzes can be used at unit loads up to 50% higher than those for leaded tin bronze alloy of C 93200 (SAE 660). As a result they need shafts quenched and tempered to 55 to 60 HRc.

Bronzes for Bushings and Sleeves are very durable materials which offer an excellent service for low speed-high load and severe duties. They also offer a good corrosion resistance.

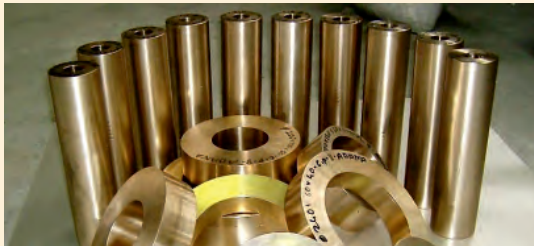

## 2. Rolling Mills

### 2.1 Slipper Pads

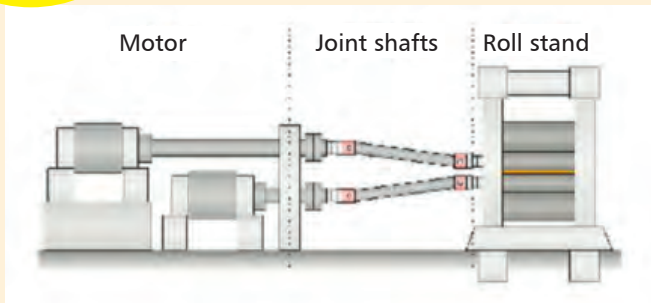
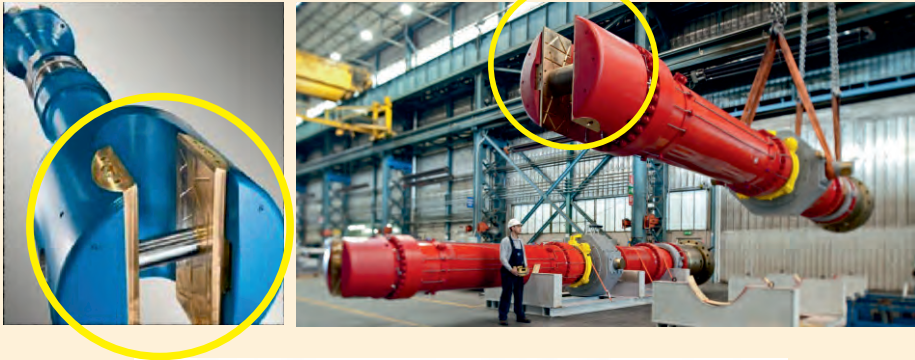

Slipper pads are extremely durable mechanical components for transmitting torque and rotation in hot and cold rolling mills. The high material elasticity of the pad allows the impact to be absorbed, therefore preventing the main machinery parts from being damaged.

**Cupral 4M** which is cast and forged aluminium bronze with nickel content is the right choice for the pads used in Hot and Cold rolling mills, Tube mills, Paper mills, Cement industries, Hydro plants etc.





### 3. Forming

#### 3.1 Tube Forming

##### 3.1.a Cold Forming of Stainless Sheets

To produce stainless steel welded tubes, steel strips are formed by cold forming rolls. If these rolls are made out of Tool steels so called cold welds might occur on the surface of the forming tools. And these cold welds damage the surface of stainless tubes. Additionally the differences in tangential speeds along the surface of the tube induce sliding between forming rolls and the stainless steel sheet. Because of the cold welding effect and the difference in speed on the forming rolls, these must be chosen out of a material with very good sliding characteristics in order to obtain an absolutely perfect surface on stainless tubes.

Advantages of **Cupral 8**:

- Extended life of the forming rolls
- Perfect stainless steel tubes end product obtained
- No hardening or expensive coatings on the forming rolls required

**Cupral 8** rolls are also used in the same production lines at the tube welding station, when producing mild steel tubes. The advantages of the **Cupral 8** rolls at the welding station are coming from the non-magnetic properties of **Cupral 8** which avoids severe heating up of the pressure rolls due to induction from the high-frequency welding loop used to seam weld the tube.

Advantages of **Cupral 8** at the welding station:

- Non-magnetic properties of **Cupral 8**
- No severe heating, easier cooling of the rolls
- Perfect mild steel tube surface quality



For tube cold rolling of stainless steel **Cupral 2**, **Cupral 4** and **Cupral 4M** can be used too used with great benefits for product and long life of the production tooling.

### 3.1.b Tube Bending (Wiperdies+Mandrels)

Wiper dies play a fundamental role in modern tube bending applications. In today's technology the tubes are bent at increasingly tight bend radii with increasingly thinner Wall thicknesses. The design of the wiper dies and mandrels play an important role in performance of the production.

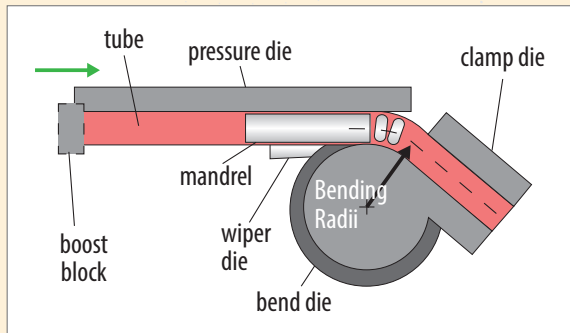

Generally the more complex bends require an internal mandrel which supports the tube. Mandrels function is to keep the tube from wrinkling and collapsing during bending operation.

Aluminium Bronzes are most common materials for wipers and mandrels. They are preferred for steel and nonferrous metals tubing. Saglam stocks high quality aluminium bronze of **Cupral 2** and Nickel Aluminium Bronze of **Cupral 4M** for the tools of bending.



Wiper Die

Advantages of **Cupral 2** and **Cupral 4M** mandrels and wiper dies:

- Extended life of the tooling lasts upto 20 times longer than steel
- Perfect stainless steel tubes final product
- Cost savings due to less downtime for maintenance
- No hardening or expensive coatings on the mandrel required
- No galling, no scratching, no corrosion starting point



Mandrell



### 3.2 Deep Drawing of Sheets

Deep drawing is a sheet metal forming process which is commonly used in mass production. Tools for metal forming should have high mechanical properties and ensure a long life time.

Aluminium bronzes are right choices for deep drawing tools and moulds due to their low resistance to friction. When it is compared with cast iron tools, they may have good sliding properties, but their wear resistance is too low.

Tools made by hardened steel show good results and long lives. But on the other hand they have a risk of galling incase of soft raw materials. Drawing moulds and drawing tools like punches can be made by **Cupral 2 or Cupral 4, Cupral 8 and Cupral 10** which is the hardest grade in deep drawing bronze grades family. These alloys combine hardness with very low resistance to friction.



#### 4. Aviation

Aluminium Bronzes are used in a wide scale in aviation too. In this segment of industry, by the years some industries formed their own specifications especially for Nickel Aluminium Bronzes.

Below is a list of most common Aluminium and Nickel Aluminium Bronzes. We as Saglam can offer all these grades in bars and in fully machined condition.



Alloys produced by Saglam for Aviation Industry;

QQ-C-645B (Aluminium Bronze)	C95510/AMS 4880 (Nickel Aluminium Bronze)
ASTM B150 (Nickel Aluminium Bronze)	C95520/AMS 4881 (Nickel Aluminium Bronze)
C63000/AMS 4640 (Nickel Aluminium Bronze)	U219Al6
C63020 (Nickel Aluminium Bronze)	AMS 4635
C95400/ASTMB -505/AMS 4871/4873 (Aluminium Bronze)	AMS 4533

## 5. Pharmaceutical Industry

Aluminium Bronzes fulfill high level standards for pharmaceutical industry as they are antibacterial, antimagnetic and high wearresistance. One of the application area of Aluminium Bronzes is Rotary High Speed Tablet Presses. These machines play a key role in production of tablets. Medical and pharmaceutical industry constantly demands new machines with higher capacity for tablets production. For Saglam the main target is to supply the bronze used in rotary tablet press turret assembly. Especially in lower cam tracks, filling cams, bushings, screws, upper cams and ejection cams can be done by our high performance Aluminium and Nickel Aluminium Bronzes series of Cupral.

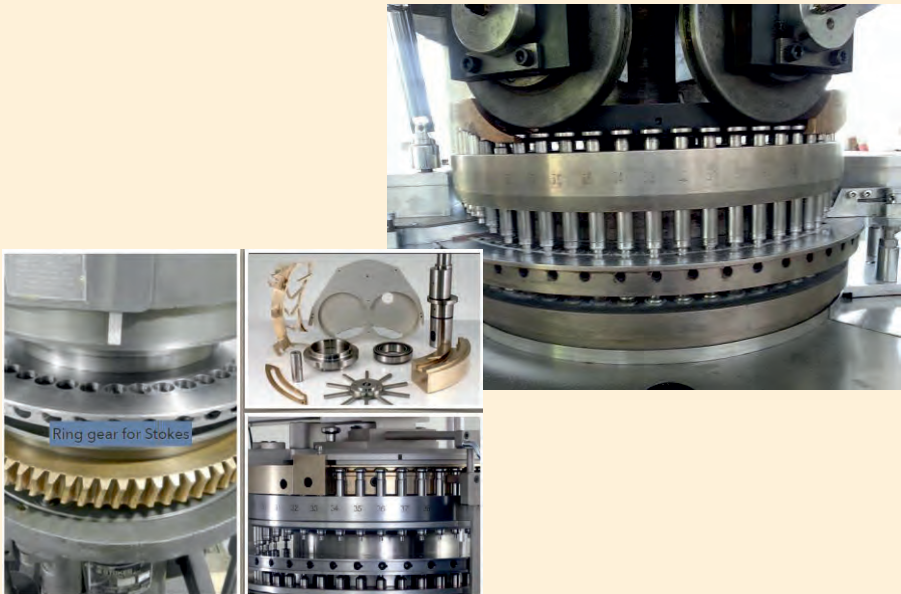

### Softgel Encapsulation Parts

Cupral 2 and Cupral 4M can be used in injection wedge designs of the Softgel Encapsulation machines. After teflon coating wedges can be ready to work. The spreader box can also be made of Bronze. Material form medicine pump worm wheel can be chosen as Aluminium Bronze too.



## 6. Non Sparking Tools

Working in hazardous atmosphere needs, non-sparking safety tools to avoid explosion, fire and personal injuries. Non sparking tools can be made of Aluminium Bronzes and some variants of copper alloy groups. Saglam offers mainly Aluminium Bronzes for this application. Our target of alloy development was done successfully and our efforts resulted in the satisfactory replacement of the Copper Beryllium alloys by an Cupral Bronze in nearly all applications without any compromise on the performance of the product.



### Non-Sparking Applications (Manufacturing):

- Alcohol Industry
- Ammunition, Missile & Explosives Plants
- Automotive Plants (Spray Booth)
- Bakery's
- Chemical Manufacturing
- Fabricated Metal Products
- Fertilizer Plants
- Flammable Materials Manufacturing
- Furniture Manufacturers
- Gas Plants & Coke Products
- Glass Manufacturing
- Liquefied Petroleum Gases
- Mining
- Nuclear Products
- Oil & Natural Gas Drilling, Refining
- Paint, Lacquer & Varnish Products, Petrochemicals
- Petroleum Refining
- Pharmaceutical Industry
- Pipeline Construction & Maintenance
- Plastic and Rubber Manufacturing

### Non-Magnetic Applications

Aircraft maintenance & overhaul, aluminum & other metal smelting, mine sweepers, nuclear products & testing machines, precision magnetic equipment (compasses & electronics -maintenance), public utilities: gas, electric & telecommunication

### Corrosion Resistant Applications

(In the presence of solids, liquids or gases where steel tools may experience severe corrosion rates) Boats, canners, chemical manufacturing plants, desalinization plants, food production, insulation manufacturing, laboratories, paper&pulp mills, petrochemicals, pharmaceutical industry, plastic manufacturing, shipyards, tankers, vessels&ships

### Governmental Agencies (Local State & Federal):

- Aircraft and Missile Plants .
- Airports (Refueling & Maintenance Operations)
- Armed Forces (Army, Navy, Air Force, Marine, Coast Guard, Civil Units)
- Chemical, Biological, Radiological, Nuclear or Explosives (CBRNE) Logistical Support / Operational Equipment.
- Fire Departments (including paid, volunteer and most military bases)
- First Responders to Weapons of Mass Destruction (WMD) including Firefighters, Public Safety Bomb Squads .
- Hazardous Materials (HAZMAT) Handling
- Nuclear Production and Waste
- Public Utilities: Gas, Electric & Telecommunication
- Waste Management
- Water Treatment Facilities

# GENERAL PRODUCTION RANGE

## COPPER ALLOYS

Commercial Name	Material	Material Code				
		UNS	DIN	EN	AMS	Other
Cupro MAX	CuCrZr	C18150	2.1293	CW106C	Class 2	-
Cupro CB	CuCo2Be	C17500	2.1285	CW104C	Class 3	-
Cupro CNB	CuCoNiBe	C17510	~2.1285	CW103C	-	-
Cupro NSS	CuNi2Si-Cr	C18000	2.0855	CW111C	Class 3	-
Cupro B2	CuBe2	C17200	2.1247	CW101C	Class 4	4533
CupNi 10	CuNi10Fe1Mn	C70600	2.0872	CW352C	-	-

## BRONZES

Commercial Name	Material	Material Code				
		UNS	DIN	EN	AMS	Other
Cupral 2	CuAl10Fe3Mn2	C62300, C62400, C95400	2.0936	CW306G	AMS 4635	-
	CuAl10Ni5Fe4	C63000, C63020, C95510	2.0946, 2.0975	CW307G, CC333G	AMS 4640	STF 22-55 B004, NFA 51116
Cupral 4M	CuAl11Fe6Ni6	C95500	2.0978, 2.0980	CW308G, CC334G	-	-
	CuAl9Ni3Fe3	-	2.0971	CW304G	-	GAM MM 11
	CuAl9Ni5Fe4	C63200	2.0976	-	-	GAM MM 11, GAM MM 13
Cupral 4	CuAl13Fe3	C62500, C95900	-	-	-	-
	CuAl14Fe5*	-	Hard Bronze With 330 HB	-	-	-
Cupral 8	CuAl14Fe4Mn2-Co	-	Hard Bronze With 360 HB	-	-	-
Cupral 10	CuAl14,5Fe5Mn2	-	Hard Bronze With 380 HB	-	-	-
Cuptin 1	CuSn7ZnPb	-	C93200	-	-	-
Cuptin 2	CuSn10	-	C90700	-	-	-
Cuptin 3	CuSn12	-	C90800	-	-	-

# Titanium-A Young Metal!

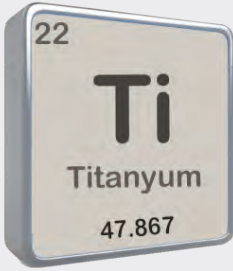

**A lightweight, high strength, low corrosion metal!**

Paramagnetic, ductile, hard, refractory, does not react with tissue and bone. Saglam has a desk which deals with **Titanium and Refractory Metals** stocks and sales.

Here's the grades of Titanium we focus on :

<p>Ti Grade 2 Pure Titanium</p>	<p>UNS R50400, W.No. 3.7035 Due to all above mentioned properties pure Titanium used in many industries like energy, medical, chemical, automotive etc.</p>
<p>Ti Grade 5 6.0 Al, 4.0 V, rest Ti</p>	<p>UNS R65400, W.No. 3.7164 5.grade alloy of Titanium (Ti6Al4V or Ti 64). High strength and low density makes this material favourite for mainly aircraft, spacecraft and ships. It can also be heat treated incase of higher mechanical properties needed. Most common used grade of Titanium alloys</p>
<p>Ti Grade 9 3.0 Al, 2.5 V, rest Ti</p>	<p>UNS R56320, W.No. 3.7164 Grade 9 Titanium (Ti3Al-2.5V) is an Alpha-Beta alloy which has great corrosion resistance and is widely used within the aerospace, chemical processing, medical processing, medical, marine and automotive markets. Possible to use this grade at higher temperatures then the other grades. Cold rolling possible</p>

Its combination of high strength, low density (it is quite light in comparison to other metals of similar mechanical and thermal properties), and excellent corrosion-resistance make it useful for many parts of aircraft, spacecraft, missiles, and ships. It also is used in prosthetic devices, because it does not react with fleshy tissue and bone.

## TunCop : Two in One!



Having high strength, high specific gravity and high temperature resistance of tungsten and combining it with high electrical conductivity of copper...

This is **TunCop!** Composed of tungsten and copper.

### Grades

TunCop 80/20

TunCop 75/25

TunCop 70/30

Although our Tungsten Copper is available in three standard chemistry steps of 5%, we can also deliver custom engineered products to allow some specific values.

### Applications:

**Aviation:** Gas and air rudders, rocket engines

**Electricity:** High voltage switches due to arc ablation resistance and anti-fusion welding

**Tool Making:** Due to all above mentioned properties of these alloys, they can be used as EDM electrodes especially for hard metals

**Resistance Welding:** They can be used to weld difficult spot welding applications like stainless steel welding and silver-nickel contact welding

**Electronics:** Semi conductor production, high power device packaging materials, heat sink materials

Our refractory metal of **TunCop 80/20** is available as finished parts with the following maximum dimensions:

Dia 4,5,6,8,10,12,14,16,18,20,22,25,30 mm

Length: 300 mm

Flat: 20x10x300 mm

# PUBLISHING

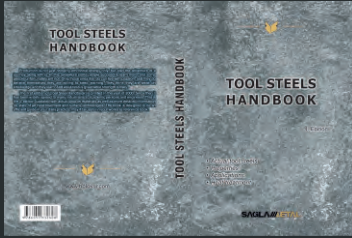

## Tool Steels Book

It is a classic book with the name "Grey Book", which was made into a more comprehensive book with the chapters added upon demand after it was published in a narrower scope in the first editions. This expanded 9th edition of the book, which has also been translated into English, Romanian and Italian, deals with modern tool steels with a wide

range of uses, such as mold, tool and machine parts making. In the book, the properties of tool steels and their usage areas and copper alloys used in the same field are discussed in a very understandable language, so that everyone has information about tool steels: "Cold work steels" Hot work steels "Plastic mold steels Powder metals "Heart design \*Metal processing" Heat treatment "Detailed Information Pages of Commonly Used Tool Steels



## Copper and Copper Alloys

In this book, the properties of copper and copper alloys explained with practical information. Book covers the following subjects:

- \*Actual pure coppers
- \*Actual copper alloys
- \*Aluminium Bronzes
- \*Applications

### \*Properties

This book is suitable for use in educational workshops and all production companies involved with copper.



## Steel Guide

This unique reference source, which was prepared by the German Steel Institute (VDEh) with a history of 300 years and has been published in 55,000 copies in four languages, has been translated into Turkish in the fifth language by Bolokur Teknik Publishing. If you are producing, using or researching steel, you can find all important information about steel in

this book. The book consists of the following main chapters. \*Cevter Preparation "High Finns" "Liquid Metal Production "Roll Forging \*Coatings "Joining Techniques Heat Treatment "Quality Management "Facility Management "Use of Steel" History of Steel Production

Author: VDEH Authors of German Steel Institute



# PUBLISHING



## **Metal and Machine Hand Tables (Tabellenbuch Metall)**

In this book, which is in its 53rd edition in Germany, all the information used in machine making, machining, mold making and other forming techniques are presented through tables. The Metal and Machine Tables Handbook has been prepared for people working in all sub-branches of the manufacturing industry. Machine, tool, mold. It contains information that will support people related to apparatus production or maintenance. It is a good reference source for anyone working in the iron and steel, automotive and sub-industry and many other sectors. This book is also suitable for use in educational workshops or course syllabuses. Ver lag Europa Lehrmittel - Germany



## **Steel Conquers the World**

This book has been written to introduce steel to young generations and is a work that tells the interesting history, present and wide usage areas of iron and steel. The book presents the readers with a gripping and easy to understand narrative of how iron ores are found in nature, how they are obtained in huge mines, how the obtained ore is melted in the furnaces, and how the produced metal is converted into steel. In this richly illustrated and fully colored book, the areas of use of iron and steel are shown with examples. The 300 year old German Iron and Steel Institute allowed the book as a 3rd language after its German and English editions, and is a good helpful resource for readers to learn. Author: Dr. Rainer Kothe -VDEH German Steel Institute



## **Very Soon**

Metal Basics: Originally titled "Fachkunde Metall", this German- or 57-printed book is the leading metalworking textbook in the country. This work, which contains information on the professions in the machinery, metal works and automotive sectors, provides information that can be applied in practice to those working in related fields, engineers, technicians and university students. This reference work, prepared in a format that provides easy access to the necessary information, helps the reader to learn and apply scientific and technical working principles.

## CAP WELDING ELECTRODES



## WIRE MESH WELDINGS



## SPOT WELDING ELECTRODES



## SEAM WELDING DISCS



## RESISTANCE WELDING ELECTRODES



## CHAIN WELDING ELECTRODES

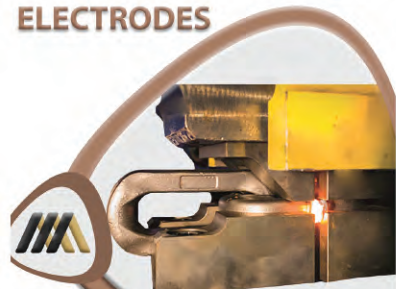

## ALUMINIUM BRONZE



## BRONZE PIPE AND PROFILE MANUFACTURING



## BRONZE BEARINGS BUSHINGS GUIDES GEAR



## FOR PLASTIC ENJECTION MOULD



## DEEP DRAWING BRONZE

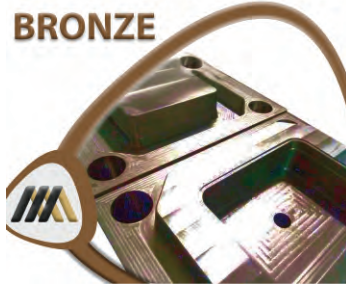

We would like to hear from you; how you can contact us?

**Saglam Metal**  
San. Tic. A.S.



- +90 850 205 20 95
- info@saglammetal.com
- Cayırova-GEBZE  
Cumhuriyet mah. No: 42  
Türkiye

[www.saglammetal.com](http://www.saglammetal.com)