

**DESIGN OF AN AMGEN TRASTUZUMAB MANUFACTURING FACILITY TO
CONTINUOUSLY PRODUCE KANJINTI, A HER2+ BREAST CANCER TREATMENT
BIOSIMILAR**

A Research Paper submitted to the Department of Chemical Engineering
In Partial Fulfillment of the Requirements for the Degree
Bachelor of Science in Chemical Engineering

Geoffrey Burns
Molly Caveney
David Lee
Joseph Letteri
Morgan Pellegrin

By

Joseph Letteri

May 14, 2021 technical paper submission

On my honor as a University student, I have neither given nor received unauthorized aid on this assignment as defined by the Honor Guidelines for Thesis-Related Assignments.

ADVISOR

Eric W. Anderson, Department of Chemical Engineering

1. Table of Contents

2. Summary

3. Introduction

3.1 Motivation and Background

3.2 Pharmacology

3.3 Treatment and Dosage

3.4 Plant Capacity

4. Discussion

4.1 Upstream Process

4.1.1 Cell Line Acquisition and Storage

4.1.2 Inoculum Train

4.1.3 Perfusion Reactor

4.1.4 Tangential Flow Filtration

4.1.5 Depth Filtration

4.1.6 Media Selection and Campaign Requirements

4.2 Downstream Process

4.2.1 Sterile Filtration

4.2.2 Protein A Chromatography

4.2.3 Viral Inactivation

4.2.4 Diafiltration for Cation Exchange Chromatography

4.2.5 Cation Exchange Chromatography

4.2.6 Diafiltration for Anion Exchange Chromatography

4.2.7 Anion Exchange Chromatography

4.2.8 Viral Filtration

4.2.9 Final Ultrafiltration and Diafiltration

4.2.10 Formulation and Filling

4.3 Ancillary Equipment

4.3.1 Pump Design

4.3.2 Tank Design

4.4 Water for Injection (WFI) System Design

4.5. Air Filtration Design

4.6 Disposal

4.6.1 Liquid Waste

4.6.2 Solid Waste

4.7 Plant Scale Market Calculations

4.7.1 Market Analysis

5. Final Design

5.1 Upstream Process

5.1.1 Cell Line Acquisition and Storage

5.1.2 Inoculum Train

- 5.1.3 Perfusion Reactor
- 5.1.4 Tangential Flow Filtration
- 5.2 Downstream Process**
 - 5.2.1 Depth Filtration
 - 5.2.2 Sterile Filtration
 - 5.2.3 Protein A Chromatography
 - 5.2.3 Viral Inactivation
 - 5.2.4 Diafiltration for Anion Exchange Chromatography
 - 5.2.5 Anion Exchange Chromatography
 - 5.2.6 Diafiltration for Cation Exchange Chromatography
 - 5.2.7 Cation Exchange Chromatography
 - 5.2.8 Viral Filtration
 - 5.2.9 Final Ultrafiltration and Diafiltration
 - 5.2.10 Formulation and Filling
- 5.3 Disposal**
 - 5.3.1 Liquid Waste
 - 5.3.2 Solid Waste
- 5.4 Production Schedule**
- 5.5 Equipment Tables and Specifications**
 - 5.5.1 Upstream Equipment Table
 - 5.5.2 Downstream Equipment Table
 - 5.5.3 Miscellaneous Equipment Table
- 5.6 Material and Energy Balances Table**
 - 5.6.1 Upstream Material Balances
 - 5.6.2 Downstream Material Balances
- 5.7 Plant Location**
- 5.8 Process Economics**
 - 5.8.1 Plant Capital Costing
 - 5.8.2 FDA Approval and Validation Costs
 - 5.8.3 Operating Expenses
 - 5.8.4 Economic Analysis using Discounted Cash Flow
 - 5.8.5 Risk Analysis
- 5.9 Quality Control**
- 6. Regulatory, Safety, Health, and Environmental Considerations**
- 7. Social and Ethical Concerns**
- 8. Conclusions and Recommendations**
- 9. Acknowledgement**
- 10. Table of Nomenclature**
- 11. References**
- 12. Appendix**

2. Summary

The purpose of this capstone design project was to design a manufacturing facility that continuously produces trastuzumab. Trastuzumab is a monoclonal antibody (mAb) that is frequently used to treat HER2+ breast cancer, esophageal cancer, and stomach cancer (*What Is Herceptin® (Trastuzumab) for HER2+ Cancer?*, n.d.). Trastuzumab was originally produced by Genentech with the brand name Herceptin®. However, after their patent expired in 2019, many companies began to produce biosimilars and enter the profitable market (Blankenship, 2020). One of those is Kanjinti® which is produced by Amgen.

This manufacturing facility will use continuous bioprocessing as it is more time-efficient, reduces energy needs, helps increase productivity and product quality, and reduces the amount of overall waste in comparison to traditional batch processes (General Kinematics, 2017). Other advantages include scalability and reduction in human error. Additionally, single-use technologies will be used in the upstream process to reduce the risk of contamination, save money on caustic cleaning chemicals, and enhance flexibility (Morrow, 2019). All of these factors will allow for a more efficient production process to inevitably provide Kanjinti to a larger patient population at a lower price.

The proposed design of this facility should produce 111.7 kg of Kanjinti per year. This will provide more accessible medicine to millions of patients. The total capital investment for this manufacturing facility is \$44.1 million. The plant will undergo construction for 1.5 years then the facility will operate at full capacity without selling the product while undergoing the FDA validation process. The timeline estimates that production and sales will begin 2.5 years after construction begins. The economic analysis determined a net present value of \$30.6 billion and internal rate of return of 38.91% for 21 years of operation. The analysis of this facility suggests a feasible project in the continuous production of trastuzumab.

3. Introduction

3.1 Motivation and Background

Cancer is a group of diseases classified by uncontrolled cell growth that is able to spread to other parts of the body in a process called metastasis. It is the second leading cause of death in the U.S., and the number of cases is increasing due to a rising and aging population (*CDC - Expected New Cancer Cases and Deaths in 2020*, 2019). With the discovery of the central dogma of biology in 1958, oncology researchers sought to target genes (i.e. oncogenes and tumor suppressor genes) and their respective proteins that interfered with proper cell growth and death. With the discovery of the *Neu* oncogene by Robert Weinstein in 1984, its human analog HER2 by Axel Uldrich at Genentech, and an antibody as an effective suppressor of HER2 activity, Dr. Dennis Slamon at UCLA paved the way for development and approval of trastuzumab, brand named Herceptin, produced by Genentech, as a breast cancer treatment by the FDA in 1998 (Mukherjee, 2011).

In 2019, patents on Herceptin expired, allowing biosimilars to enter the market. A biosimilar is a therapeutic that has no clinically meaningful difference in safety, purity, and potency from an existing FDA-approved therapeutic. Due to the Biologics Price Competition and Innovation Act of 2009, Amgen was able to take a shorter pathway in the drug approval process by proving their biosimilar, Kanjinti, was interchangeable with Herceptin (FDA, 2019b). This pathway was established as a way to provide more treatment options, increase access to life saving medication, and potentially lower health care costs through competition. We intend to produce Kanjinti, or trastuzumab, continuously and with single-use technologies. Continuous bioprocessing enables higher rates of facility utilization while ensuring increased flexibility, better cost-efficiency, and improved overall product quality. Single-use technologies also save both

utility and labor costs by reducing cleaning and sterilization demands. With both continuous and single-use technologies, we will be able to increase product yields with a decrease in the cost of production. This will inevitably increase the accessibility of this lifesaving mAb therapeutic to vast patient populations by decreasing the market price.

3.2 Pharmacology

The HER-2 receptor (erbB-2) is a transmembrane tyrosine kinase receptor that consists of an extracellular ligand-binding domain with no known corresponding ligand, a transmembrane region, and an intracellular or cytoplasmic tyrosine kinase domain. It is activated by the formation of homodimers or heterodimers with other EGFR proteins, leading to dimerization and autophosphorylation and/or transphosphorylation of specific tyrosine residues in EGFR intracellular domains. Further downstream molecular signaling cascades are activated, which promote cell growth, survival, and cell cycle progression. Due to upregulation of HER2 in tumour cells, hyperactivation of these signaling pathways and abnormal cell proliferation is observed. The active substance in Kanjinti, trastuzumab, binds to the extracellular ligand-binding domain (Fig 3.1) and prevents dimerization or modification of HER2 to induce cell downmodulation, and inhibits MAPK and PI3K/Akt pathways (Fig 3.2). Inhibition of these pathways lead to an increase in cell cycle arrest, and the suppression of cell growth and proliferation. In addition to its inhibitory effects, trastuzumab mediates the activation of antibody-dependent cell-mediated cytotoxicity by attracting the immune cells, such as natural killer cells, to tumor sites that overexpress HER2 (*Trastuzumab*, n.d.). Trastuzumab has an approximate isoelectric point (pI) of 8.7 and molecular weight of 185 kDa.

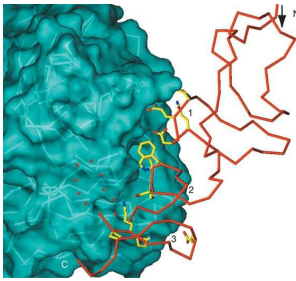

Figure 3.1: Trastuzumab (cyan) binding to HER-2 (orange/yellow) (Cho et al., 2003)

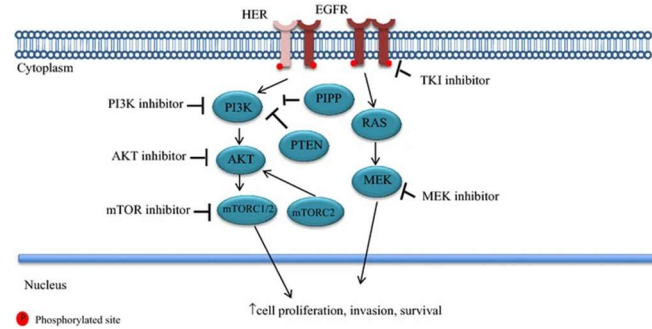

Figure 3.2: Trastuzumab cell pathway targets (Costa et al., 2018)

3.3 Treatment and Dosage

Kanjinti is a HER2/neu receptor antagonist used for the treatment of HER2 overexpressing breast cancer and metastatic gastric cancers. HER2 is overexpressed in approximately a quarter of breast cancers and a fifth of gastric cancers. Patients will be treated for an initial dose of 4 mg/kg over 90-minute IV infusion, then subsequent 30-minute IV infusions of 2 mg/kg for 12 weeks or 18 weeks. One week after the last weekly dose of Kanjinti, 6 mg/kg over 30-90 minutes will be administered every three weeks for a total of 52 weeks (Amgen, 2019).

All laboratory studies have shown that the active substance Kanjinti is highly similar in terms of structure, purity, and biological activity to that in Herceptin. Similarly, in one study conducted by the European Medicines Agency where 696 patients with early breast cancer that overexpressed HER2 were treated with Herceptin or Kanjinti, 41% of those given Herceptin and 48% of those given Kanjinti had no invasive cancer cells in the breasts.

The trastuzumab final product is a sterile, white to pale yellow, lyophilized powder. It is designed for intravenous administration. The nominal content of each trastuzumab vial is 420 mg trastuzumab, 9.5 mg L-histidine HCl monohydrate, 6.1 mg L-histidine, 381.8 mg a,a-trehalose dihydrate, and 1.7 mg polysorbate 20. Reconstitution with 20 mL of the supplied bacteriostatic

water for injection, USP, containing 1.1% benzyl alcohol as a preservative, yields a multi-dose solution containing 21 mg/mL of trastuzumab. Trastuzumab vials should be stored in a refrigerator at 2°C to 8°C between deliveries and should be used within 28 days (Amgen, 2019).

3.4 Plant Capacity

With an increasing cancer patient population in the United States, the demand for monoclonal antibody (mAb) treatment is consequently increasing. The global mAb market is projected to generate \$300 million in revenue by 2025 (Lu et al., 2020). The sale of Herceptin totaled to \$6.08 billion dollars in 2019 and is projected to have only \$2.08 billion in sales in 2026 (Blankenship, 2020). This decline of sales is due to trastuzumab biosimilars entering the market at the end of 2019 due to the expiration of Roche's patent on Herceptin. For this reason, our team wanted to produce a more accessible therapeutic to be sold at a lower price. Amgen's biosimilar, Kanjinti, was able to capture 17% of the original market in 2019. Genentech sold Herceptin at \$1,636 per 150 mg vial, and Kanjinti will be made available at a more accessible price of \$1,338 per 150 mg vial. Taking into account the average price of these therapeutics, 111.7 kg of Kanjinti will be needed to continue to capture 17% of the trastuzumab market which is about \$1.034 billion USD. All information and assumptions are based on average dosage and price numbers, but the team does recognize that patient assistance programs do exist to limit the cost of the drug.

4. Discussion

4.1 Upstream Process

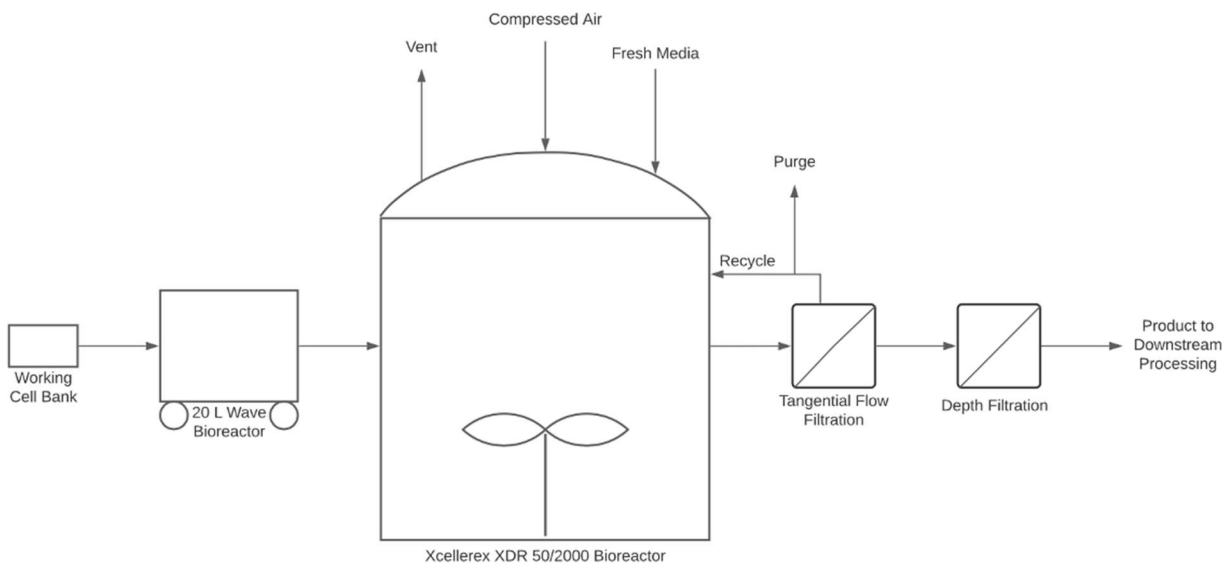

Figure 4.1. Process flow diagram for the upstream process.

4.1.1 Cell Line Acquisition and Storage

The recombinant Chinese Ovarian Hamster cells (CHO cell) is a type of cultivated mammalian cell. Recombinant mammalian cells are considered to be industry dominant due to their ability to properly fold, assemble, and modify proteins for clinically acceptable use (Wurm, 2004). Amgen already upkeeps an FDA-approved master cell bank near the desired facility location at their headquarters in Thousand Oaks, CA, which should eliminate delivery delays or possible logistical complications. Prior to cryopreservation and delivery of cells, the manipulated CHO cells will be subjected to tests to determine product disposition and to ensure quality and viability from the start of the process. Such tests require specifications regarding the identity of cells, purity of solution, and potency of the desired product of the cell bank, as specified in the International Conference on Harmonisation of Technical Requirements for Registration of

Pharmaceuticals for Human Use (ICH) specifications Q6B: Test Procedures and Acceptance Criteria for Biotechnological/Biological Products (Akel, 2015).

Cell lines are delivered and stored in 4.5 mL vials with a density of $50 * 10^6$ cell/mL. Storage of cells, especially at a high density, requires suspension of growth and metabolism in order to suppress foreign growth and genetic mutations. Metabolic reactions within a cell are inhibited at temperatures below $-80^{\circ}C$, but cells suspended in a below-freezing aqueous environment are typically destroyed (McKinney, 2018). The addition of a cytoprotective agent (e.g. DMSO, glycerol, dextran, methanol) increases solute concentration both within the cell and extracellularly, thereby suppressing ice formation. Cell bank vials can be stored in a VIP Series Model MDF-U76VC-PA Freezer, which maintains a temperature of $-87^{\circ}C$ (Panasonic Healthcare Corporation, 2016). Cell lines typically are thawed in a warm-water bath, and thawing rates should be as rapid as possible ($>1^{\circ}/s$ for most mammalian cells). The Thermo Fisher Precision GP 02 water bath will be used for thawing before cell introduction to inoculum train (Thermo Fisher Scientific, 2021b).

4.1.2 Inoculum Train

To minimize the number of steps in the seed train, a high cell density and appropriate substrate concentration must be used. Minimizing the time spent in the lag phase of cell growth allows for a greater amount of growth time in the exponential phase, therefore increasing productivity. To model cell growth, substrate concentration, and product concentration, we will use Monod kinetics and assume Type I fermentation. Type I fermentation assumes the protein product is a primary metabolite, and it assumes the product concentration is directly related to the cell concentration through a constant yield coefficient (Fig. 4.2a). The kinetics data used for these

steps was obtained from a study using an infliximab monoclonal antibody derived from CHO cells. Infliximab is also an IgG monoclonal antibody with a molecular weight of 149 kDa, which is an acceptable 3.47 kDa heavier than trastuzumab (146 kDa) (López-Meza et al., 2016). Along with the Monod equation, a system of three differential equations can be used to calculate substrate, cell, and product concentrations over time (Fig. 4.2b).

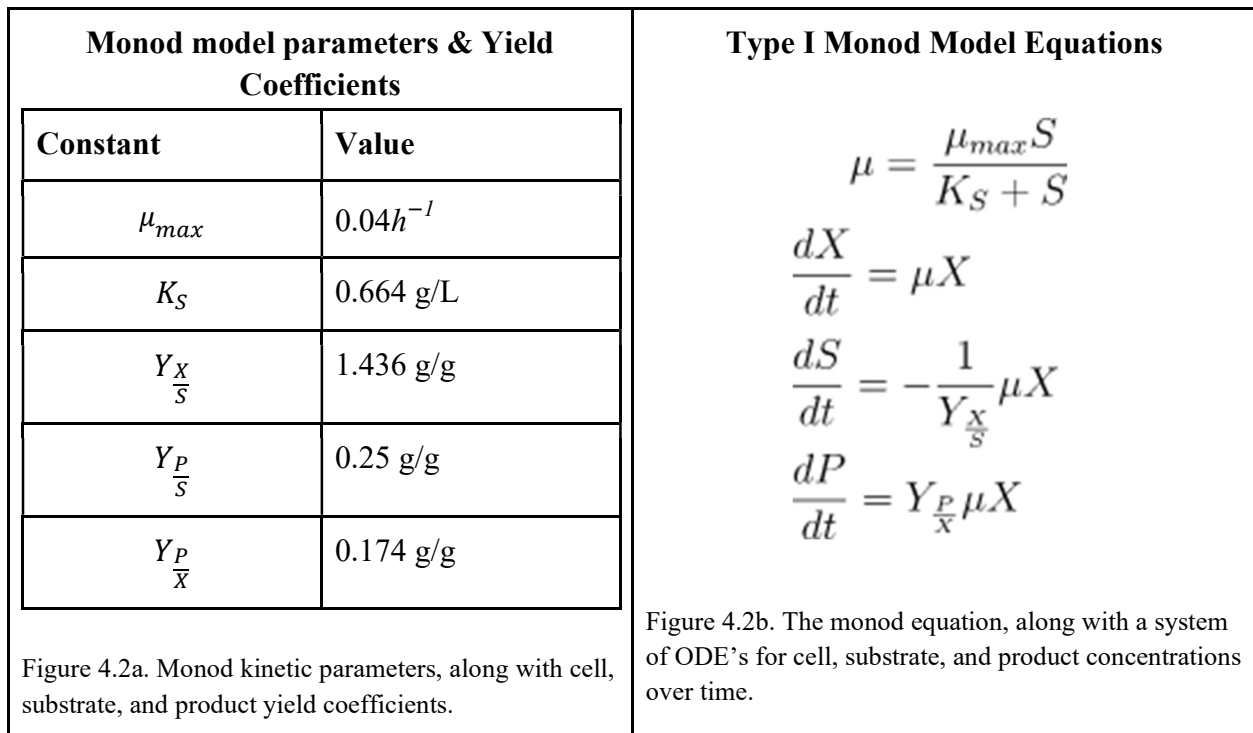

The overall scale-up process is shown in Figure 4.3 below.

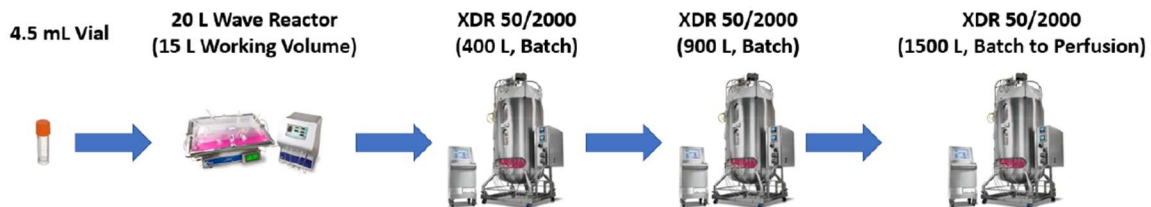

Figure 4.3. Scale-up process equipment and requirements from 4.5 mL vial to 1500 L XDR 50/2000 perfusion reactor (GE Healthcare, 2018c).

The working cell bank is split into high-density vials according to GMP guidelines. These high-density vials contain increased total viable cell numbers and volume per vial, and using them can reduce upstream manufacturing time by 9 days (Tao et al., 2011). The time reduction is due to multiple culture expansion steps, which typically involve shake flasks scaling up to 15 L, being eliminated from the seed train. Using high-density vials has been shown to not impact performance in terms of cell growth or process productivity, so there is no known downside to using them.

As discussed in a GE Healthcare upstream processing manual, the cells in the high-density vials are stored frozen, so they need to be thawed and suspended in 100 mL of prewarmed, fresh culture medium. Once suspended, the cells will be transferred to a 20 L cell bag perfusion bioreactor. The following process has been proven to be successful using GE's ReadyToProcess WAVE25 rocking bioreactor system. The cell bag must be prefilled with 900 mL of fresh media, so when the suspended cells are added the media is inoculated and the cells can begin to multiply. In the 20 L cell bag, fresh media will be slowly introduced until the final working volume is 15 L. The rocking speed of the Wave reactor will be set to 20 RPM and then increased to 25 RPM after 10 hours as recommended by the GE Healthcare (GE Healthcare, 2015). Two Wave reactors will be purchased with one to be held as backup. After the Wave reactor, the fermentation broth will be sent to an XDR 50/2000. The XDR 50/2000 provides a predictable and seamless scalability and flexibility needed for large-scale manufacturing with a minimum and maximum working volume of 400 L and 2000 L as well as the ability to be operated in batch, fed-batch, and perfusion mode (GE Healthcare, 2018c). The basic scale-up sequence will include the 15 L Wave reactor to a 400 L working volume in a XDR reactor bag to 900 L to 1500 L. Again, two XDR 50/2000 reactors will be purchased in case of failure and to entertain the necessary maintenance. The impeller is located at the bottom of the reactor to ensure that no matter what volume is in the reactor it will

all be agitated evenly. No extra consideration must be given to the impeller and mixing during the inoculation train.

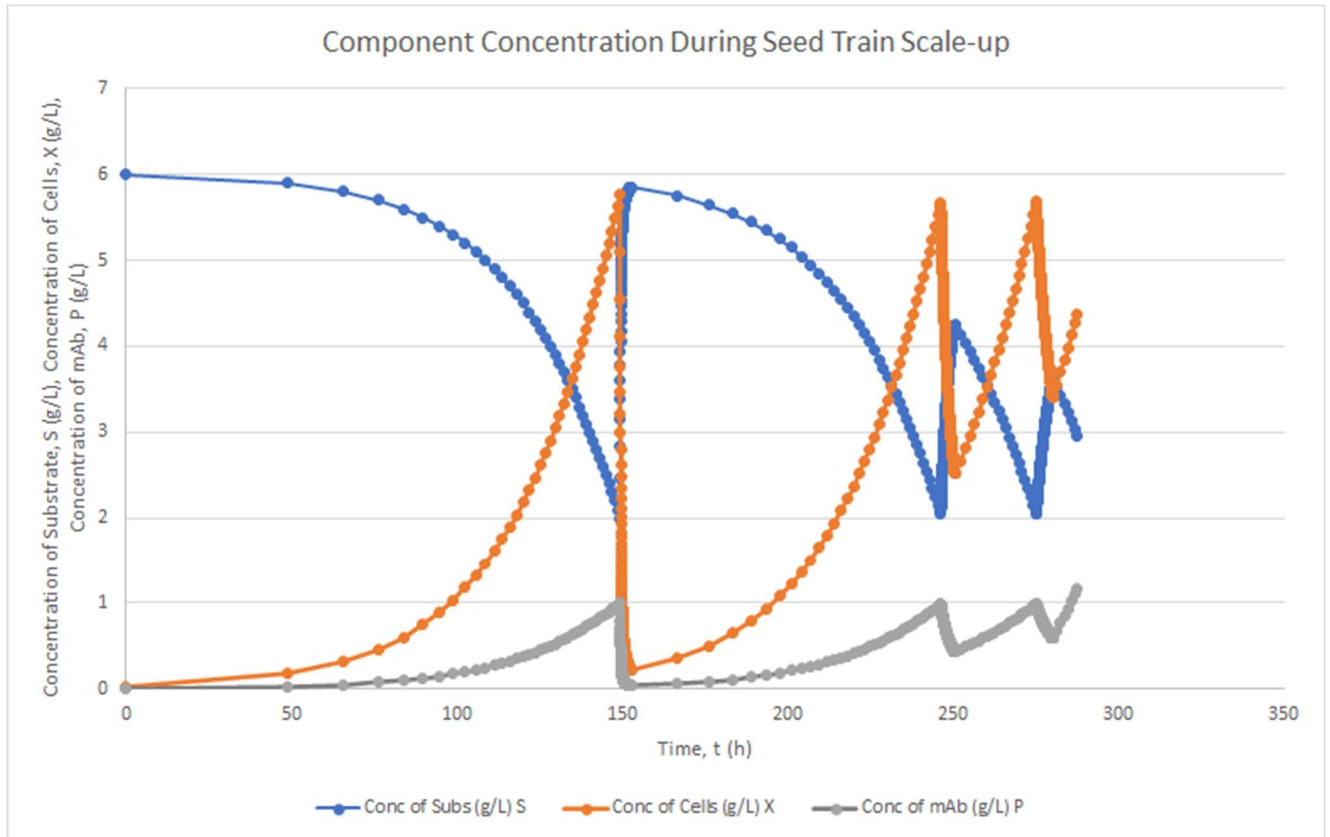

Figure 4.4. Component concentration during seed train scale-up.

The component concentrations over time are given in Figure 4.4 above. The beginning of the process will include 100 mL of media added to the 4.5 mL vial to suspend the cells. The initial recorded cell concentration will be 0.03 g/L, and the added media will bring the initial substrate concentration to 6 g/L and initial media concentration 34.92 g/L. Previous works used a larger substrate concentration, however 6 g/L was chosen to ensure minimal side metabolic pathways disrupting the growth of the cells. Side metabolic pathways may create products that inhibit cell growth, such as lactic acid. Similarly, if too much glucose is added to the system the cells will experience inhibition due to shock. At the 1500 L volume, 6000 g of additional glucose is added

to allow the cells to grow to a higher concentration. This amount of glucose brings the substrate concentration slightly higher than the media's glucose concentration (7.62 g/L compared to 6 g/L), so it is assumed it will not be high enough to shock the cells. Pure glucose was chosen because it is the primary substrate of the chosen media and the basis for cell growth at each scale. The cell, substrate, and trastuzumab concentration throughout the seed train was calculated using the Monod parameters and equations presented above in Figure 4.2. For each scale-up step the process was stopped when the concentration of glucose reached 2 g/L as per recommendations from Thermo Fisher for the Gibco High-Intensity Perfusion media (Thermo Fisher Scientific, 2021a). To begin scale-up, the vial of suspended cells will be added to 14.9 L of media in the 20 L wave reactor bag. After 149 hours the contents of the wave reactor will be transferred to the 400 L reactor bag in the Xcellerex XDR reactor. The concentration of CHO cells, substrate, and trastuzumab leaving the 15 L process will be 5.77 g/L, 2 g/L, and 1.0 g/L, respectively. There is a short time segment added into each step to account for the loading of material and preparation of the reactor bag and vessel (Watson Marlow Fluid Technology Group, 2021). Loading will be done at 2 L/min due to the pump capabilities. After adding in 385 L of media, the starting substrate concentration will return to 5.85 g/L while the concentration of CHO cells and trastuzumab will be 0.217 g/L and 0.0375 g/L, respectively. After 246 total hours since the cell vial, the broth will then be transferred to the 900 L reactor bag. The concentration of CHO cells, media, and trastuzumab leaving the 400 L process will be 5.67 g/L, 2.05 g/L, and 0.988 g/L. After adding in 500 L of media, the starting substrate concentration will return to 4.24 g/L, while the concentration of CHO cells and trastuzumab will be 2.52 g/L and 0.439 g/L, respectively. After 275 total hours since the cell vial, the broth will then be transferred to the 1500 L reactor bag. The concentration of CHO cells, substrate, and trastuzumab leaving the 900 L process will be 5.68 g/L, 2.04 g/L, and 0.989 g/L,

respectively. After adding in 600 L of media, the starting concentration of CHO cells, substrate, and trastuzumab will be 3.41 g/L, 3.63 g/L, and 0.593 g/L, respectively. An additional 6000 g of glucose will be added to the reactor bag to bring the substrate starting concentration to 7.63 g/L. The outlet concentration of CHO cells and trastuzumab leaving the 1500 L batch process and entering the perfusion process after 314.52 hours since the cell vial will be 11.45 g/L and 1.99 g/L respectively. At this point, the cell concentration will be the steady state concentration desired for perfusion operation to produce the protein product.

4.1.3 Perfusion Reactor

The perfusion bioreactor that was selected is Cytiva's Xcellerex XDR 2000 Pro Single-Use stirred-tank bioreactor. This bioreactor was chosen for numerous reasons. The first is its flexibility of working volumes, which is important because the bioreactor needs to handle volumes ranging from 400L to 1500L when operating in batch mode during the inoculum train. Secondly, this bioreactor has a disposable bag and impeller system which is important for maintaining a sterile environment for cell growth and minimizing down-time for routine cleaning and maintenance. This disposable bag system reduces costs and time by eliminating clean-in-place and steam-in-place operations (Cytiva, 2020). Lastly, Cytiva's Xcellerex XDR bioreactors are proven bioreactor systems that are commonly used in industry because of their added controls for perfusion operation. When operating at steady state during perfusion mode, the bioreactor will have a working volume of 1500 L of fluid. This working volume will be maintained throughout each 30-day campaign. Perfusion bioreactors can operate for upwards of 2-3 months in perfusion mode while maintaining a constant viable cell density. However, 30 days was selected in order to reduce the likelihood and severity of potential contamination.

The inner tank and impeller dimensions for the XDR 2000 Pro are given below in Table 4.1 with the corresponding diagram in Figure 4.5. The bioreactor will operate at 37°C and 1 atm.

Table 4.1. Xcellerex XDR 2000 Pro Single-use stirred-tank dimensions.

Parameter	Value	Unit
D_t	123	cm
H_t	183	cm
V	2000	L
D_i	42	cm
H_b	61	cm

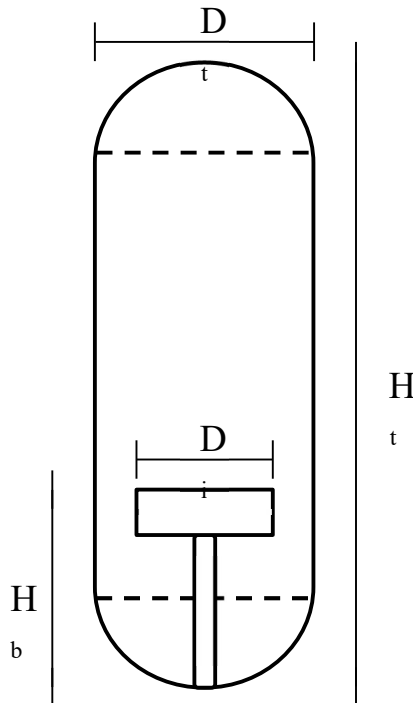

Figure 4.5. Xcellerex XDR 2000 Pro Single-use stirred-tank bioreactor dimensions diagram (not drawn to scale).

The single-use technology of the XDR bioreactor makes it an excellent choice for perfusion operation. The XDR bag is constructed with low-density polyethylene plastic making it robust under a wide range of processing conditions. The XDR bag system also incorporates a seal-less impeller assembly with a bottom-mounted impeller/sparger that couples with the magnetic drive head (Cytiva, 2020). The single-use bioreactor bag, impeller, and sparger system makes the XDR

bioreactor highly effective with minimal down-time between campaigns. The disposable impeller is a magnetically coupled, M40e 40°, pitched-blade impeller (four blades) with ceramic bearings that enhance overall performance. Incorporated into the XDR 2000 Pro bioreactor system are built-in conventional polarographic sensors for dissolved oxygen measurements and glass electrodes for pH monitoring. The sensors will be autoclaved between campaigns and prior to use to prevent contamination.

Compressed air will be fed to the bioreactor to provide the CHO cells with a sufficient oxygen concentration. The oxygen demand was determined using a steady-state assumption that the rate of oxygen transferred to the CHO cells is equal to the rate of oxygen consumption (Davis & Davis, 2003). With this assumption, the following equation (Equation 4.1) can be used to determine the mass transfer coefficient (K_La) that will be held constant when scaling up to design the bioreactor operations.

$$K_La = q_{O_2}X / (C_{O_2}^* - C_{O_2})$$

Equation 4.1. Steady-State approximation to determine oxygen mass transfer coefficient

In this equation, q_{O_2} is the cell oxygen consumption rate, X is the cell density, $C_{O_2}^*$ is the solubility of oxygen in water at 37°C and 1 atm, and C_{O_2} is the minimum concentration of oxygen. These parameters are listed in Table 4.2 below.

Table 4.2. Aeration parameters for Xcellerex XDR 2000 Pro Single-use stirred-tank bioreactor.

Parameter	Value	Unit
q_{O_2}	0.83	mmol/g-h
X	11.45	g/L
$C_{O_2}^*$	6.7	mg/L
C_{O_2}	1.35	mg/L
K_La	56.5	h^{-1}

The CHO cell oxygen consumption rate was obtained from literature for CHO cells and using the steady-state cell concentration (Goudar et al., 2011). The solubility of oxygen at 37°C

and 1 atm was determined using solubility tables for oxygen in water (Xylem, 2019). The minimum oxygen concentration, also known as the critical oxygen concentration, was approximated as 20% of the solubility (George Prpich, 2020, p. 17).

Knowing the oxygen mass transfer coefficient for the CHO cells, this parameter was held constant and used to scale-up the bioreactor design for 1500 L working volume operation. The following equations were used to determine the bioreactor operating specifications.

$$Re = ND_i^2 \rho / \mu$$

Equation 4.2. Reynolds number equation for stirred-tank bioreactor

$$P = N_P \rho N^3 D_t^5$$

Equation 4.3. Power requirement equation for stirred-tank bioreactor

$$N_a = Q_g / ND_i^3$$

Equation 4.4. Aeration number equation for stirred-tank bioreactor

$$K_L a = \frac{0.0333}{D_t^4} \left(\frac{P_g}{V} \right)^{0.541} Q_g^{0.541 / \sqrt{D_t}}$$

Equation 4.5. $K_L a$ correlation for stirred-tank bioreactor

In Equation 4.2, Re is the Reynolds number, N is the impeller rotational speed in rpm, ρ is the density of solution which is assumed to be constant at 997 kg/m^3 , and μ is the dynamic viscosity which is assumed to be 0.001 kg/m-s . In Equation 4.3, P is the power requirement in watts and N_P is the power number which is equal to 0.72 for the four-blade XDR 2000 Pro disposable impellers (GE Healthcare, 2018c). In Equation 4.4, N_a is the aeration number, and Q_g is the aeration rate in vvm. Lastly, in Equation 4.5, P_g is the power input for a gassed system, which is equal to 0.97

times the power requirement for this system based on the correlation between P_g and the calculated N_a for our system (George Prpich, 2020).

With these parameters, the impeller rotational speed and aeration rate were optimized in order to achieve the desired oxygen mass transfer coefficient while maintaining sufficient mixing and operating under cGMP guiding conditions. This includes that the Cytiva XDR bioreactor manuals suggest that the impeller tip speed should remain below 15 s^{-1} to avoid a high shear rate for the shear-sensitive CHO cells (GE Healthcare, 2018c). Optimizing under these guidelines, the optimum rotational speed and aeration rate were determined to be 178 rpm and 0.144 vvm respectively. At these operating conditions, the KLa was calculated to be 56.7 h^{-1} , which is well within 10% of the target value and successfully scales up the operation to the intended 1500 L working volume scale.

Knowing the operating conditions of the bioreactor, the material balances surrounding the bioreactor could be solved at steady state to determine the stream conditions entering and exiting the bioreactor. When the bioreactor is switched to perfusion mode, the continuous process begins and the working volume within the bioreactor remains constant. As fresh media enters the bioreactor, cells and media are passed to the TFF unit which separates the mAb and small molecules from the cells. The mAb product and small molecules, along with small amounts of cell debris, pass through the filter membrane as permeate which is then sent to the depth filtration unit prior to downstream purification steps. The main components of the TFF retentate include cells, both viable and spent, as well as water which are partially recycled and partially purged to waste.

During this continuous process, it's important to consider the dilution rate, which is defined in Equation 4.6 below:

$$D = \frac{F_0}{V}$$

Equation 4.6. Dilution rate equation, where F_0 is the flow rate of fresh media and V is the working volume within the bioreactor.

As shown in Figure 4.6 below, a sample graph of cell and substrate concentrations vs. dilution rate, the dilution rate has a significant impact on the output of cells and therefore product generation as well.

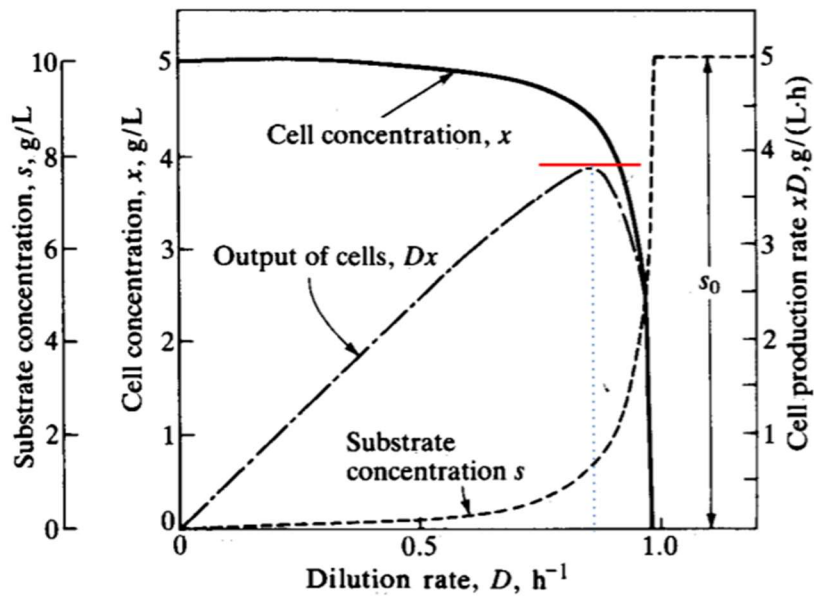

Figure 4.6. Sample graph illustrating the dependence of effluent concentration s , cell concentration x , and cell production rate xD , on continuous culture dilution rate D as computed from the Monod chemostat model. Modified from (Prpich, 2019).

Figure 4.6 illustrates how a maximum output of cells occurs at an optimum dilution rate, indicated by the red line. This optimum dilution rate for a chemostat with recycle can be calculated by setting the derivative of productivity equal to zero. This is done using the previously determined growth parameters and the design equations below:

$$D = \frac{\mu_{\max} S}{(K_s + S)(1 - a(b - 1))} \quad \frac{d(DX)}{dD} = 0$$

$$X = Y_{x/s}(S_o - S)$$

$$S = \frac{DK_s(1 - a(b - 1))}{\mu_{\max} - D(1 - a(b - 1))} \quad \begin{array}{l} b = X_r/X_1 = \text{conc. factor} \\ a = F_r/F_o = \text{recycle ratio} \end{array}$$

Equations 4.7a-7d. Design equations for chemostat with recycle where X_r is the concentration of cells in the recycle stream, X_1 is the concentration of cells exiting the bioreactor and being fed to the TFF unit, F_r is the recycle flow rate, and F_o is the flow rate of fresh media to the bioreactor.

After substitution and solving the differential equation, the resulting equation can be used to determine the optimal dilution rate:

$$0 = S_o Y_{x/s} - Y_{x/s} K_s (1 - a(b - 1)) \left[\frac{2D}{\mu_{\max} - D(1 - a(b - 1))} + \frac{(1 - a(b - 1))D^2}{(\mu_{\max} - D(1 - a(b - 1)))^2} \right]$$

Equation 4.8. Optimal dilution rate equation.

Using this equation, the optimum dilution rate for the bioreactor was determined to be 0.0287 h^{-1} .

This was set as our target dilution rate when designing our continuous bioreactor operating conditions. In addition, Figure 4.8 shows that a washout point occurs beyond the optimum dilution rate at which cell growth is inhibited by a too large substrate concentration. The dilution rate at the washout point can also be calculated using the kinetic growth parameters, as shown in Equation 4.9 below:

$$D_{\text{washout}} = \frac{\mu_{\max} S_o}{(K_s + S_o)(1 - a(b - 1))}$$

Equation 4.9. Washout dilution rate equation based on kinetic growth parameters.

Using this equation, the washout dilution rate for our bioreactor was determined to be 0.0377 h^{-1} . This value was also considered when optimizing the recycle flow rate to the bioreactor, as to avoid washout when satisfying the material balance. The actual dilution rate for our bioreactor was calculated using Equation 4.10.

$$D = \frac{\mu_{\max} S}{(K_s + S)(1 - a(b - 1))}$$

Equation 4.10. Actual dilution rate equation.

For the perfusion calculations, the diagram shown in Figure 4.7 below outlines the steady state process with labeled streams.

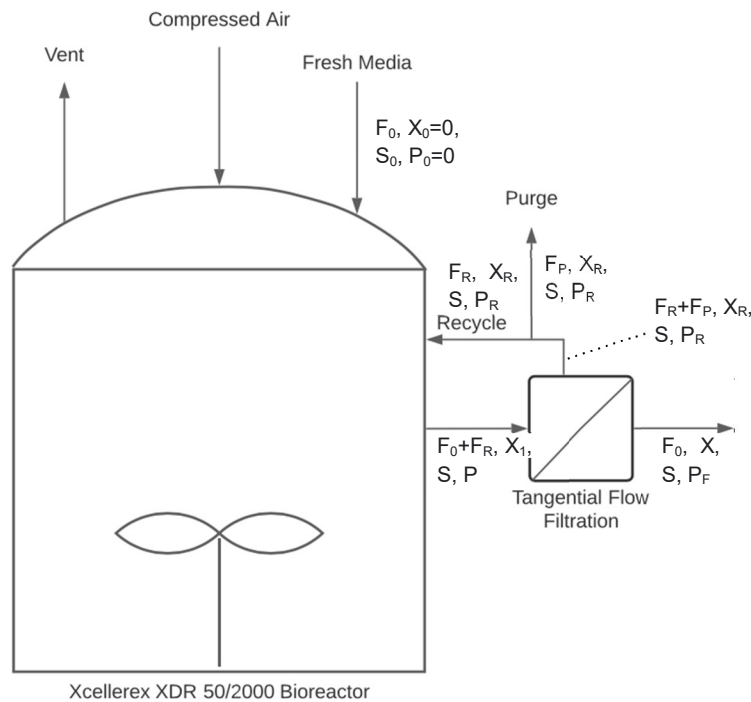

Figure 4.7. Labeled streams for material balance surrounding bioreactor and TFF units during perfusion mode. Modified from (Xu et al., 2020).

The added fermentation broth stream has a fixed substrate concentration of 6 g/L glucose. The permeate exiting the TFF also has a fixed mAb concentration of 4.08 g/L and flow rate of 0.081 L/min (determined from the downstream calculations outlined in section 4.2). With these fixed

values, the recycle flow rate and the fresh media flow rate were varied to achieve the desired permeate conditions and dilution rate. It was also assumed that 10% of the solution passing through the TFF unit will pass through the membrane as permeate. Of this 10%, it was assumed that 99.9% of trastuzumab in solution passes through the TFF filter while 99.9% of cells are retained (this assumption is further discussed in section 4.1.4). The remaining flow rates and concentrations were calculated using overall and unit material balances, as well as the Monod design equations (Figure 4.2b). These values are presented in Table 4.3 below.

Table 4.3. Stream specifications surrounding Bioreactor and TFF unit operating in perfusion mode.

Stream	Feed	XDR to TFF	Recycle	Purge	Permeate
F (L/min)	0.87	1.66	0.79	0.79	0.081
X (g/L)	0	11.45	12.03	12.03	0.23 (lysed)
S (g/L)	6.0	1.68	1.59	1.59	3.44
P (g/L)	0	1.99	1.89	1.89	4.08

Operating under these stream conditions, the actual dilution flow rate was calculated to be 0.0274 h^{-1} , which is slightly lower than the optimum dilution rate of 0.0287 h^{-1} to avoid any accidental washouts which would occur at a dilution rate of 0.0377 h^{-1} .

4.1.4 Tangential Flow Filtration

Connecting the bioreactor to the depth filtration unit is the tangential flow filtration unit. A tangential flow filtration unit was chosen over an alternating tangential flow filtration unit because it has been shown to result in higher cell densities in the permeate, which results in higher yields (Clincke et al., 2013). In this unit operation, the trastuzumab is continuously harvested from the solution containing the CHO cells while the whole cells are returned to the bioreactor. It is also important to have a purge stream coming off of the recycle stream to prevent a buildup of nonviable cells and maintain a stable and productive cell population (Yavorsky et al., 2003). This also prevents a volume buildup due to the continuously added fermentation broth. A pump circulates

the cell culture through a cartridge made of spiral hollow fiber membranes which acts as the filter to allow the mAb to pass through while sending the rest of the cell culture back to the bioreactor. Impurities contained within the cell culture include debris from cells that have been lysed, DNA, lipids, and undesirable proteins. As mentioned prior, it was assumed that 10% of the solution coming from the bioreactor to the TFF would pass through the TFF membrane as permeate. Of that 10 %, it was assumed that 99.9% of the mAb passes through the TFF due to the mAb diameter (10.8 nm) being significantly smaller than the filter pore size (0.2 μm). It was also assumed that 99.9% of the cells, whole cells only, are retained and recycled to the bioreactor based on its diameter of 0.4 to 10 μm . Specifically, the ÄKTA flux tangential flow filtration system from Cytiva will be used (Cytiva, 2021a). This particular unit fits due its working volume up to 8L, flexible single-use filter sizes, and desirable permeate flow rate capabilities (GE Healthcare, 2018b). The flow rates and concentrations surrounding the TFF were calculated using Figure 4.9 above and the aforementioned balances that accompany it as summarized in Table 4.10 above.

The following equations were used to calculate the pressure drop across the membrane for the TFF:

$$Re = \frac{4Q}{\pi d v}$$

$$f = \frac{16}{Re}$$

$$\frac{\Delta P}{L} = \frac{32 f \rho Q^2}{\pi^2 d^5}$$

Equations 4.11a-11c. Calculating the pressure drop across the TFF

The TFF model has a membrane area of 110 cm^2 , fibers with diameters of 1 mm, and a 30 cm nominal flow path. The kinematic viscosity of the solution was estimated to be that of water at

37°C. Using the equations above, the pressure drop was calculated to be 1.66 psi which is well within the maximum transmembrane pressure of 45 psig (Cytiva, 2021a).

4.1.5. Depth Filtration

After TFF, the solution will pass through a depth filtration unit which will filter out cell debris from lysed cells that made it through the TFF as well as larger impurities. Smaller impurities like DNA may be removed in lesser quantities and will be filtered out in the downstream process. The Millistak+® HC Pod Depth Filter, A1HC media series will be treated as single use since the large particles being filtered may clog the pores. Table 4.4 below shows the specifications of the depth filtration operation.

Table 4.4. Specifications of the depth filter

Filter Area	0.11	m ²
Length	62	cm
Max Op. P	30	psid
Temp.	25	°C

Figure 4.8 below shows that the flow rate of 0.081 L/min corresponds to a differential pressure of about 0.35 psi which is below the max operating pressure (Millipore, 2019).

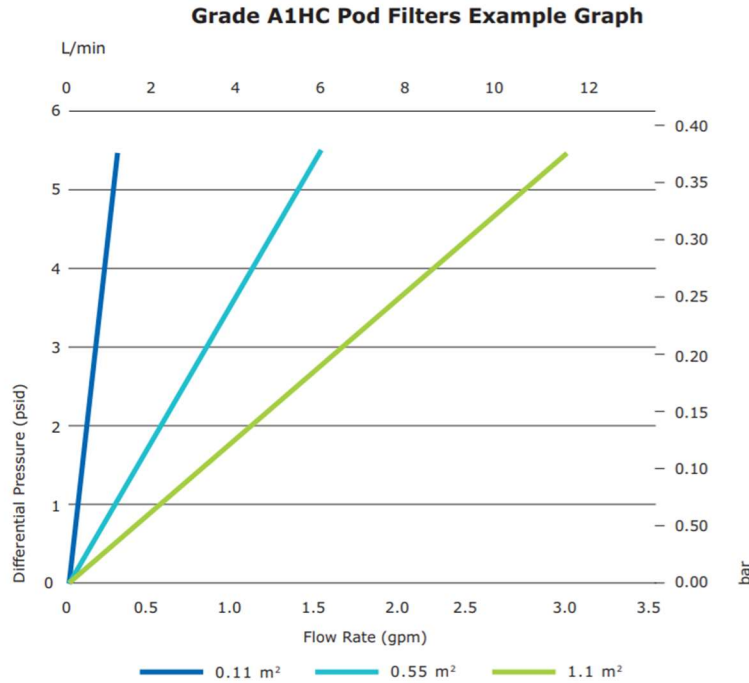

Figure 4.8. Data connecting flow rate and differential pressure for depth filtration (Millipore, 2019).

4.1.6 Media Selection and Campaign Requirements

We selected ThermoFisher Gibco High Intensity Perfusion Media due to its compatibility with our cell bank recombinant CHO-S cells, along with its versatility of maintaining a high viable cell density at every stage in our inoculum train and throughout a full perfusion cycle (Thermo Fisher Scientific, 2021a). The media will be held in a storage tank. To prepare the media, the following recipe will be used per Gibco's manual (Thermo Fisher Scientific, 2020):

1. Measure 90% of the final volume of deionized or distilled water at room temperature (15°C to 30°C).
2. Add HIP CHO Medium at 34.92 grams/L to water.
3. Mix for a minimum of 20 minutes.
4. Using a calibrated vessel, dilute to final production volume with ambient
5. deionized or distilled water.

6. Mix for an additional 20 minutes.
7. Measure the pH, then check and record osmolality.
8. Sterilize immediately by membrane filtration (positive pressure recommended).

At this media concentration, the concentration of substrate, or glucose, is 6.0 g/L.

4.2 Downstream Process

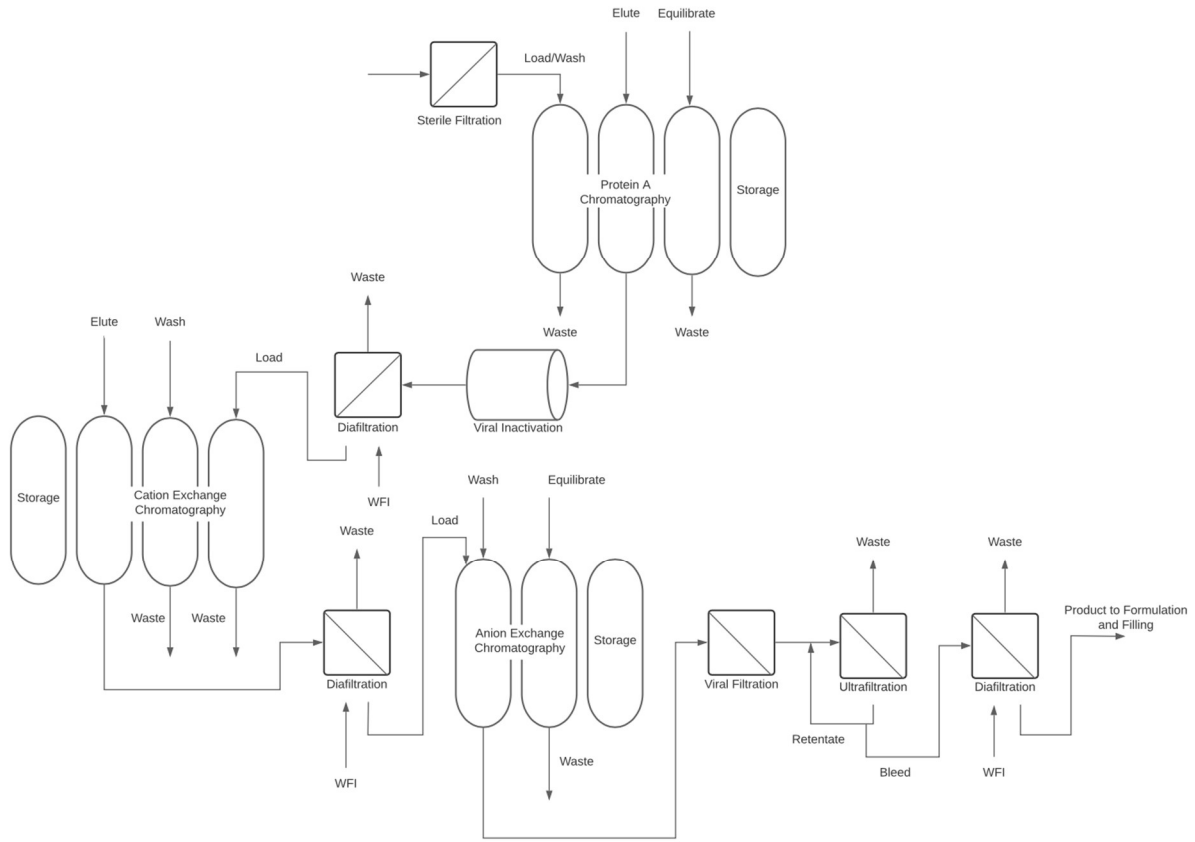
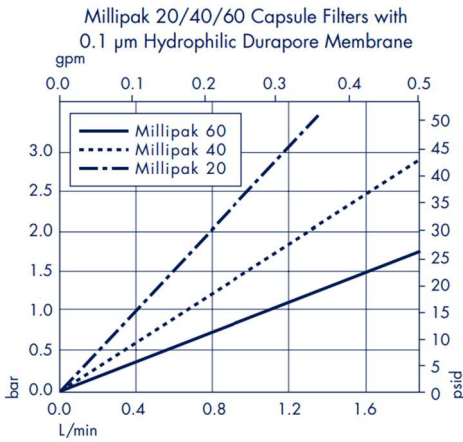

Figure 4.9. Process flow diagram for the downstream process.

4.2.1 Sterile Filtration

Sterile filtration is a unit operation that uses a membrane composed of polyvinylidene fluoride (PVDF). Millipak sterile filtration cartridges are stacked disc filters designed for the removal of particles and microorganisms immediately succeeding the overall upstream process. The stacked disc design without a support fleece allows minimal hold-up volume and particle shedding, allowing the discs to withstand high pressure applications (Zhang et al., 2019). Since Millipak filters are made with PVDF membranes, they can tolerate high flow rates, throughputs, low extractables, broad chemical compatibility and the lowest protein binding of any membrane

available (Millipore, 2004). A low protein binding capacity allows for high separation between the desired mAb product and waste aggregates. Millipak suggests an initial wet test at 1 LPM/0.1m²filter area for 5 minutes. Based on the flowrate from the initial depth filtration of 0.081 L/min and usage of the Millipak 60 (0.1 μm), the corresponding differential pressure across the membrane will be 0.25 bar (Fig 4.10).



Specifications		
	Millipak 20	Millipak 40
Nominal Dimensions		
Nominal length:	8.4 cm (3.3 in.)	8.9 cm (3.5 in.)
Nominal diameter:	76 mm (3.0 in.)	76 mm (3.0 in.)
Filtration Area	100 cm ² (0.11 ft ²)	200 cm ² (0.22 ft ²)
Pore Sizes	0.1 μm, 0.22 μm and 0.45 μm	

Figure 4.10. Millipak sterile filtration differential pressure for specified flow rates & dimensions.

4.2.2 Protein A Chromatography

Protein A Chromatography is capable of absorbing our final product with high specificity by utilizing a *Staphylococcus aureus* ligand. The ligand’s high biospecific affinity towards the Fc region of any IgG antibody is achieved through the five binding domains of the ligand (de Taeye et al., 2019). Since this chromatography step retains the mAb protein produced in the perfusion reactor, cell debris and any other undesired aggregates pass through as waste during washing. The elution step creates an acidic effluent stream containing the mAb that allows for further downstream processing. Protein A chromatography with high performing resins typically achieves mAb protein purity greater than 99%.

As the desired protein begins to occupy available ligands, a maximum concentration of bounded protein will be reached, known as the dynamic binding capacity (DBC). In addition to the identity of the ligand, the DBC is dependent on column geometry and linear fluid velocity. Once the DBC has been reached from the loaded volume, undesired aggregates are washed out of the column with a neutral buffer and brought to waste. The elution phase uses an acidic buffer and allows for our product to unbind from the ligand to be further purified. Lastly, the column must be cleaned, regenerated, and equilibrated before it is loaded again. Buffer specifications by column volume are listed below (Table 4.5).

Table 4.5. Buffer composition & amount required for Protein A chromatography (Cytvia Life Sciences, 2021).

Phase	Buffer	# of CV's
Load	Depth Filtrate	20
Wash	25 mM Tris, pH 7.4 + 100 mM NaCl	5
Elute	50 mM acetate, pH 3.5	20
Regenerate	100 mM phosphoric acid	5
Equilibrate	25 mM Tris, pH 7.4 + 100 mM NaCl	5
Clean	0.1 M NaOH	5

By manipulating pH, which plays a role in determining the interaction strength between substances and the ligands, we can alter the interactions happening at the ligands. By using a low pH buffer in the elution phase, the mAb protein is released and collected. The resin is then subjected to a regeneration protocol which removes any leftover substances and primes the ligands to once again accept mAb protein solution (Carta & Jungbauer, 2010). We will perform this step using Cytvia Life Sciences MabSelect Prisma Resin (Cytiva, 2021b). Prisma resin offers an industry-leading dynamic binding capacity (DBC), as well as enhanced alkaline stability for improved robustness (Fig 4.11) (Cytvia Life Sciences, 2021)

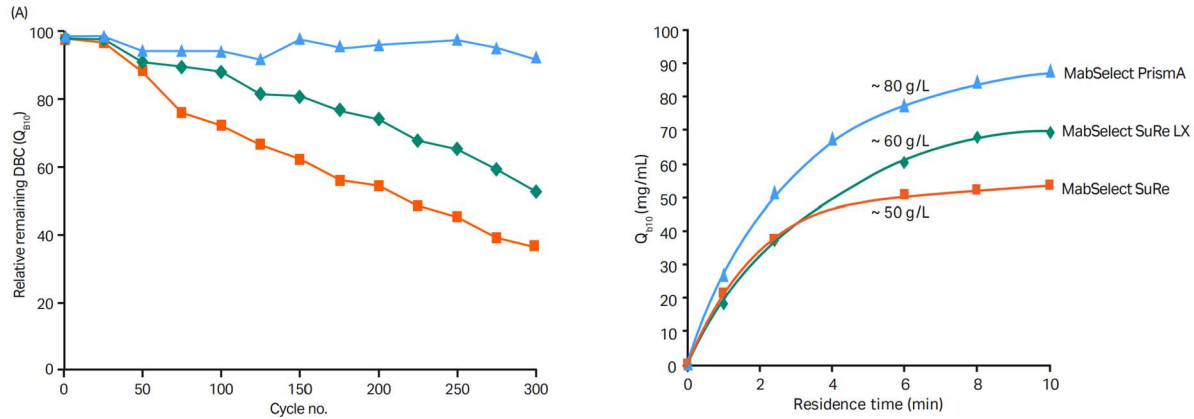

Figure 4.11. DBC vs. Cycle No. & Residence Time (Cytiva, 2021)

This resin is a premier high throughput resin which has a high dynamic binding capacity at both low and high linear flow rates, as well as being able to withstand numerous cycles with low particle loss. This resin has an average particle size of 65 μm and a well-defined dynamic binding capacity of 80 g/L resin at the desired residence time of 6 minutes as seen in Figure 4.11. Based on our TFF effluent stream volumetric flow rate, we chose a column diameter of 0.05 m and a bed height of 0.1 m, resulting in a column volume of 0.196 L. The PrismaA resin will be operated in a XK 50/20 column. Operating three columns in parallel on a tightly regulated schedule as shown in Table 4.6 will allow for continuous output of purified mAb product at a flow rate of 0.08 L/min and a concentration of 3.66 g/L. The waste flow rate and concentration from washing and cleaning are 0.162 L/min and 0.033 g/L. A fourth column will be held for backup purposes.

Table 4.6. Proposed schedule protein A chromatography column.

Column 1	20 CV				5 CV	20 CV			5 CV	5 CV	5 CV
	Flow rate = 0.081 L/min				0.033 L/min	0.081 L/min			0.033 L/min		
	Load				Wash	Elute/Collect			Regene rate	Equilib rate	Clean
Column 2	20 CV	5 CV	5 CV	5 CV	20 CV			5 CV	20 CV		
	0.081 L/min	0.033 L/min			0.081 L/min			0.033 L/min	0.081 L/min		
	Elute/Collect	Regenerate	Equilib rate	Clean	Load			Wash	Elute/Collect		
Column 3	5 CV	20 CV			5 CV	5 CV	5 CV	20 CV			
	0.033 L/min	0.081 L/min			0.033 L/min			0.081 L/min			
	Wash	Elute/Collect			Regene rate	Equilib rate	Clean	Load			

With a total cycle time of 360 min; the proposed time breakdowns are 120 min for loading, 30 min for washing, 120 min for eluting, and 30 min each for cleaning, regenerating, and equilibrating.

4.2.3 Viral Inactivation

To maintain FDA approval and patient safety, the viral load must be cleared. Low pH is an effective way to denature viruses without denaturing the mAb product. Most viruses are denatured at a pH of 5.0-5.5, but enveloped viruses typically denature at a pH of 3.5-4.0 (Mettler-Toledo International, 2021). Viral inactivation takes place directly after Protein A chromatography because the elution stream is already at a pH of 3.5. Holding the fluid at a pH of 3.5 for 14.5

consecutive minutes has been shown to result in complete viral inactivation, so the reactor will be designed for the fluid to maintain at least 15 minutes in the reactor (Mettler-Toledo International, 2021).

A coiled flow inverter (CFI) plug flow reactor (PFR) will be used to maintain continuous operations. The helical design creates secondary flow patterns, or Dean vortices, based on centrifugal force. This results in more radial mixing and a narrower residence time distribution (RTD). It is important to minimize the RTD to maintain more control over the process; a smaller RTD means each volume of fluid is spending a smaller range of time in the reactor, so there will be more homogenous viral inactivation. The 90° bend changes the direction of the centrifugal force and results in more Dean vortices and more radial mixing.

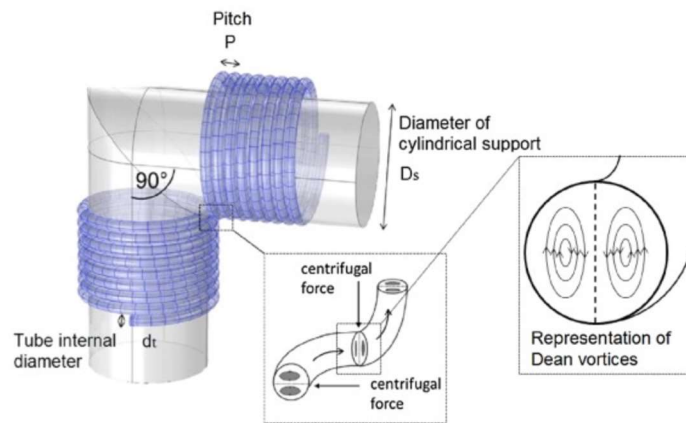

Figure 4.12. Schematic of a 90-degree bend in a CFI (Rossi et al., 2017)..

The narrowest RTD has been shown to occur at a Dean number $De > 3$, bend angle of 90°, and at least two turns in one coil (Rathore et al., 2016). The Dean number can be calculated using the following equation.

$$De = \frac{Re}{\sqrt{\lambda}}$$

Equation 4.12. Dean number calculation from Reynolds number (Re) and the inversion ratio (λ), where λ is the ratio between the tube diameter and helix diameter.

The reactor will be designed with a length of 5 m, a tube diameter of 0.025 m, and a helix diameter of 0.125 m with 2 turns per coil. This results in a Re of 57.3 and a De of 4.05. This Re represents laminar flow. Laminar flow is preferred for viral inactivation because laminar flow has a nonuniform flow pattern and axial dispersion. The RTD for a laminar flow reactor is shown below (University of Michigan, 2017).

$$E(t) = \begin{cases} 0 & t < \frac{\tau}{2} \\ \frac{\tau^2}{2t^3} & t \geq \frac{\tau}{2} \end{cases}$$

Equation 4.13. Residence Time Distribution Function for Laminar Flow Reactor, where τ is the space time, or nominal holding time.

For a laminar flow reactor, the mean residence time is equal to the space time, and the minimum time the fluid may spend in the reactor is half of the mean residence time as shown below.

$$t = \frac{L}{U_{\max}} = \frac{L}{2U_{\text{avg}}} \left(\frac{\pi R^2}{\pi R^2} \right) = \frac{V}{2v_0} = \frac{\tau}{2}$$

Equation 4.14. Minimum time spent in a Laminar Flow Reactor where L is the length of the reactor, U is the velocity, R is the radius of the reactor, V is the volume of the reactor, v_0 is the volumetric flow rate, and τ is the space time.

To guarantee that the fluid spends at least 15 minutes in the reactor, the mean residence time will be double 15 minutes, or 30 minutes. This reactor will be custom made and purchased from Parr Instrument Company because of their experience in the pharmaceutical industry and their experience with CFI reactors.

4.2.4 Diafiltration for Cation Exchange Chromatography

Diafiltration is a common technique that uses an ultrafiltration membrane to replace the specific buffer the protein and solution are suspended in. Diafiltration also works to completely remove, replace, or lower the concentration of salts or solvents from the protein solution (Schwartz, 2003). The process uses permeable membrane filters to separate the components of a

solution based on their molecular size. A typical ultrafiltration membrane retains molecules larger than the diameter of the pores while small molecules such as water, solvents, and salts pass through freely (Schwartz, 2003). In continuous diafiltration, the original buffer salt is removed from the permeate and a new, fresh replacement buffer is added to the retentate at the same rate as the filtrate is generated. When continuous diafiltration is used, 99.9% of the permeable solute can be removed by washing with at least 7 diavolumes of the new buffer (Schwartz, 2003). To accomplish this 99.9% buffer exchange, the buffer flow rate must be 7 times the feed flow rate. This is shown in Figure 4.13 below in comparison to the less than advantageous discontinuous, or batch, diafiltration.

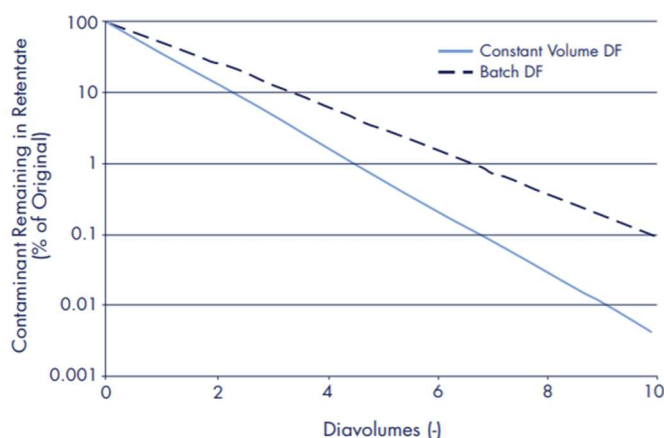

Figure 4.13. Retentate volume and buffer exchange during batch and constant-volume diafiltration (Millipore, 2003).

Continuous diafiltration will be used prior to cation exchange chromatography (CEX) to raise the pH of the acidic mAb solution coming from viral inactivation. The process of lowering the pH during viral inactivation and readjusting the pH before CEX can form aggregates in solution that need to be removed via chromatography (Wälchli et al., 2020). To perform this diafiltration step, a Cadence™ Inline Diafiltration Module will be used (Pall Corporation, 2021a). This unit will be fit with twelve filter cassettes: Pall Delta 30 kDa T-series TFF Cassettes (Pall Corporation, 2021b). This module is selected because it is a fully continuous diafiltration unit, and it functions

at the feed flow rate coming from the VI unit. It also has a low shear rate which prevents product degradation and protein aggregation. The T-Series Cassettes are designed for mAb bioprocessing with maximum mass transfer through the membrane, which results in a faster processing time. This is important for a continuous process because slow processing time may result in backup. For all diafiltration units, we will assume a constant flux across the filter membrane, no cake formation on the surface of the membrane, and no concentration polarization (Carta, 2020). These assumptions are valid given the very slow flow rates for these processes.

There are three diafiltration steps in the downstream process: prior to cation exchange chromatography, prior to anion exchange chromatography, and prior to final formulation. Each step will require its own Cadence Inline Diafiltration module. Each module uses 12 filter cassettes that will be replaced after each batch. For the first diafiltration unit, we will be using twelve 186 cm² filter cassettes. This will provide a total of 0.22 m² of membrane surface area. The solution will enter the diafiltration unit at a flow rate of 0.081 L/min and have a concentration of 3.66 g/L. Based on the feed flow rate and membrane area, the transmembrane pressure will be 38 psi to ensure 99.9% buffer replacement with 7 diavolumes. WFI will enter the diafiltration unit at a flow rate of 0.567 L/min and the permeate will exit at 0.567 L/min with a mAb concentration of 0.00364 g/L. The bleed stream will exit the diafiltration unit at a flow rate of 0.081 L/min with a mAb concentration of 3.64 g/L. This bleed stream will be the load for CEX. The mass balance and respective calculations are presented below.

$$\begin{aligned} \sigma &= 0.999 \\ C_P &= C_B(1 - \sigma) = (3.64 \text{ g/L})(1 - 0.999) = 0.00364 \text{ g/L} \\ C_F Q_F &= C_B Q_B + C_P Q_P \\ C_F(0.0810 \text{ L/min}) &= (3.64 \text{ g/L})(0.0810 \text{ L/min}) + (0.00364 \text{ g/L})(0.567 \text{ L/min}) \\ C_F &= 3.66 \text{ g/L} \end{aligned}$$

4.2.5 Cation Exchange Chromatography

Ion exchange chromatography separates ions and molecules based on their overall surface charge. In cation exchange chromatography (CEX) the resin is negatively charged, so positively charged species bind to the resin while negatively charged contaminants flow through the column. Using a buffer with a pH below the isoelectric point of trastuzumab results in the mAb having a net positive charge, which will bind to the resin. Gradient elution can be performed to capture the mAb while separating the desired mAb from other contaminants and aggregates. Ion exchange chromatography is ideal for reducing high molecular weight aggregates, charge-variants, residual DNA and host cell protein, leached Protein A resin, and viral particles (Liu et al., 2010).

The CEX column will use Cytiva's Capto S Impact Resin because of its high binding capacity and small particle size. This resin is commonly used in industrial applications because of its high resolution and flexibility of process design when removing impurities similar to the target product (GE Healthcare, 2016). The Capto S Impact Resin is developed by GE Healthcare and has a long-term pH stability of 4 to 12 hours and a mean particle size of 50 μm . The dynamic binding capacity (DBC) was conservatively estimated to be 95 mg/mL from Figure 4.14 below of dynamic capacity as a function of residence time.

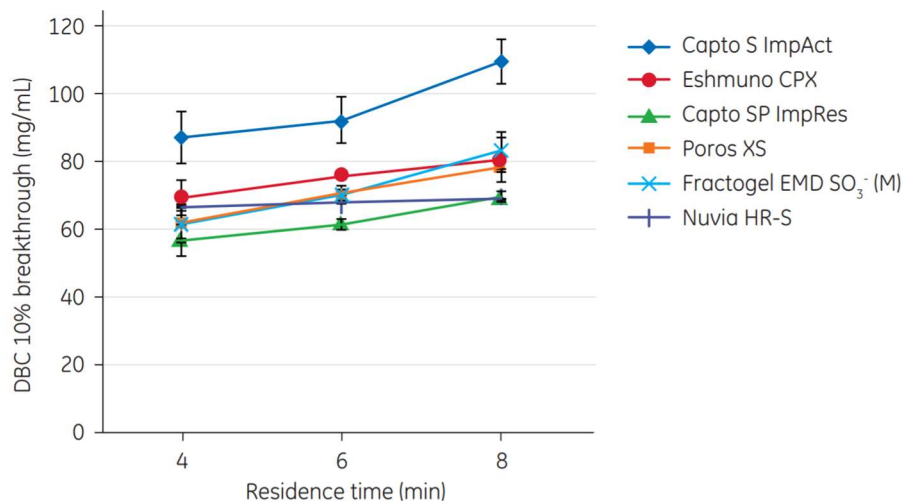

Figure 4.14. Dynamic binding capacity as a function of residence time (GE Healthcare, 2014).

The buffer for CEX will be a 50 mM sodium acetate solution to ensure that the desired mAb (pI 8.7) has a net positive charge while the contaminants (pI ~ 2-5) have a net negative charge (Mayer et al., 2015). The positive mAb will bind to the negatively charged ligands of the resin. The buffer used in elution will include 1.0 M NaCl. This gradient of added salt in high concentration is necessary because the pI of trastuzumab is relatively high. The salt gradient separates the protein of interest from other bound proteins leading to the capture of trastuzumab (*Cation Exchange Chromatography | LSR | Bio-Rad*, n.d.). The specific buffers and proposed column volumes required for each step in the CEX capture column are presented below in Table 4.7.

Table 4.7. Buffers and column volumes for cation exchange chromatography (CEX)

Phase	Buffer	Amount (CV)
Load	50 mM Sodium Acetate @ pH = 5.0w/ mAb	27
Wash	50 mM Sodium Acetate	5
Elute	50 mM Sodium Acetate + 1.0M NaCl	27
Clean	0.1M NaOH	5
Regenerate	50 mM Sodium Acetate + 1.0M NaCl	5
Re-Equilibrate	50 mM Sodium Acetate	5

The column was chosen to be run at 80% of the maximum allowable linear velocity for the Capto S Impact Resin, which is 0.0293 m/min. The residence time was chosen to be 6.5 min to yield the conservative estimate of 95 mg/mL for the dynamic binding capacity as presented in Figure 4.14. The column length was calculated to be 0.190 m using the residence time of 6.5 min and the recommended linear operating velocity of 0.0293 m/min using Equation 4.15.

$$Residence\ Time = L * u$$

Equation 4.15. Calculation for column length (L) given chosen linear velocity (u) and residence time for ideal dynamic binding capacity.

Using a standard diameter of 0.05 m and a height of 0.190 m, the volume of the column was determined to be 0.373 L. The AxiChrom 50/300 column by Cytiva will be used, which has an adjustable bed height that may vary between 0.10-0.30 m and an inner diameter of 0.050 m. The load volume was calculated to be 7.96 L using the following Equation 4.16.

$$DBC_{10} = \frac{V_{load} C_F}{V_{col}}$$

Equation 4.16. Loading volume calculation from dynamic binding capacity, column volume, and concentration.

The extraparticle porosity was assumed to be 0.3, and the viscosity of trastuzumab was estimated to be 0.0012 Pa*s using an IGg1 model for a mAb with a pI of 8.7 (Li et al., 2014). Shown in Equation 4.17, the Carman-Kozeny equation is used to calculate the pressure drop of a fluid flowing through a packed bed of solids. The column pressure was calculated to be 17.6 psi, which is well within the threshold of the chosen column.

$$\Delta P = \frac{150(1 - \epsilon)^2}{d_p^2 \epsilon^3} L u \eta$$

Equation 4.17. Carman-Kozeny equation used to calculate column pressure.

Three CEX columns will be operated simultaneously to keep the process continuous. The first column will continuously load, the second will continuously elute, and the third will be regenerating and equilibrating. There will also be a fourth column held in the facility for back-up and larger scale cleaning operations. The proposed schedule is presented below in Table 4.8. The concentrations of the inlet and outlet are designed to be 3.638 g/L and 3.274 g/L respectively assuming a 90% retention of mAb.

Table 4.8. Proposed schedule CEX column.

Column 1	27 CV				5 CV	27 CV			5 CV	5 CV	5 CV	Wait
	Flow rate = 0.0810 L/min				0.058 L/min	Flow rate = 0.0810 L/min			Flow rate = 0.058 L/min			
	Load				Wash	Elute/Collect			Clean	Regene rate	Equilib rate	
Column 2	27 CV	5 CV	5 CV	5 CV	Wait	27 CV			5 CV	27 CV		
	0.0810 L/min	Flow rate = 0.058 L/min				Flow rate = 0.0810 L/min			0.058 L/min	Flow rate = 0.0810 L/min		
	Elute/Collect	Clean	Regene rate	Equilib rate		Load			Wash	Elute/Collect		
Column 3	5 CV	27 CV			5 CV	5 CV	5 CV	Wait	27 CV			
	0.058 L/min	Flow rate = 0.0810 L/min			Flow rate = 0.058 L/min				Flow rate = 0.0810 L/min			
	Wash	Elute/Collect			Clean	Regene rate	Equilib rate		Load			

The proposed time breakdowns are for a total of 526.5 min with 175.5 min for loading, 32.5 min for washing, 175.5 min for eluting, 32.5 min each for cleaning, regenerating, and equilibrating, and 45.5 min of wait time.

4.2.6 Diafiltration for Anion Exchange Chromatography

Prior to anion exchange chromatography, the sample pH must be raised to approximately 7 so that it is below the pI of trastuzumab (pI 8.7) but higher than the pI of most contaminants (pI = 2-5). This ensures that the desired protein is positively charged and the majority of contaminants are negatively charged. Then, when the column is loaded, the protein will pass through and be collected while the negatively charged contaminants will bind to the positively charged column

resin. Therefore, this diafiltration step is necessary to achieve the desired separation of contaminants from protein during anion exchange chromatography.

To raise the pH, continuous diafiltration will be used to replace the 50 mM sodium acetate buffer with WFI (pH 7). This diafiltration step will be designed under the same assumptions as the previous diafiltration unit. Like the previous unit, this module will have twelve 186 cm² filter cassettes for a total membrane area of 0.22 m². To achieve 99.9% buffer replacement with 7 diavolumes, the diafiltration module will have a pressure drop of 38 psi. Using the same material balance equations as the first diafiltration unit, the inlet and outlet streams were calculated. The solution enters the diafiltration unit at a flow rate of 0.081 L/min with a mAb concentration of 3.27 g/L. WFI will enter the diafiltration unit at a flow rate of 0.567 L/min, and the permeate will exit at 0.567 L/min with a mAb concentration of 0.00325 g/L. The bleed stream will exit the diafiltration unit at a flow rate of 0.081 L/min with a mAb concentration of 3.25 g/L. This exiting stream will be the load for anion exchange chromatography. The mass balance and respective calculations are presented below.

$$\begin{aligned}\sigma &= 0.999 \\ C_P &= C_B(1 - \sigma) = (3.25 \text{ g/L})(1 - 0.999) = 0.00325 \text{ g/L} \\ C_F Q_F &= C_B Q_B + C_P Q_P \\ C_F(0.081 \text{ L/min}) &= (3.25 \text{ g/L})(0.081 \text{ L/min}) + (0.00325 \text{ g/L})(0.567 \text{ L/min}) \\ C_F &= 3.27 \text{ g/L}\end{aligned}$$

4.2.7 Anion Exchange Chromatography

Anion exchange chromatography (AEX) is similar to CEX, but it has a positively charged resin that binds negatively charged species. In the proposed design, the positively charged trastuzumab flows through the column while negatively charged contaminants, such as DNA, virus fragments, and host cell proteins, bind to the column (GE Healthcare, 2018a).

This AEX column will use Cytiva’s Capto Q Resin due to its specific design for high production purification of mAbs, which includes high volumetric throughput, shorter process times, and a high dynamic binding capacity (DBC) at high flow rates (GE Healthcare, 2021a). The Capto Q Resin has a highly cross-linked agarose matrix that has been treated with dextran surface extenders and a strong quaternary ammonium anion exchanger, which allows it to combine high throughput with high DBC (GE Healthcare, 2021a). Additionally, the structure of the resin is durable and allows it to keep a positive charge across a range of pHs (GE Healthcare, 2021a). The specifications of the Capto Q include a particle size of approximately 90 µm, operating pressures up to 58 psi, and flow rates up to approximately 0.23 m/min (GE Healthcare, 2006).

WFI will dilute the Buffer D solution from CEX to a pH of approximately 7 to ensure that the desired mAb (pI 8.7) is positive while the contaminants (pI = 2-5) are negative. The proposed buffers for AEX are given in the following table.

Table 4.9. Buffers and column volumes for anion exchange chromatography (AEX)

Phase	Buffer	Amount (CV)
Load	WFI (Buffer D dilution from CEX)	39
Wash	Buffer D (50 mM sodium acetate in 1.0M NaCl)	2
Clean	0.1M NaOH	5
Regenerate	Buffer D (50 mM sodium acetate in 1.0M NaCl)	5
Equilibrate	Buffer D (50 mM sodium acetate in 1.0M NaCl)	5

The DBC, which is the maximum amount of mAb that can be loaded onto the column without extra loss, was estimated to be 124 mg/mL using the following Figure 4.15 from Cytiva. This high value will help prevent unnecessary loss of protein and minimize the volume of resin needed.

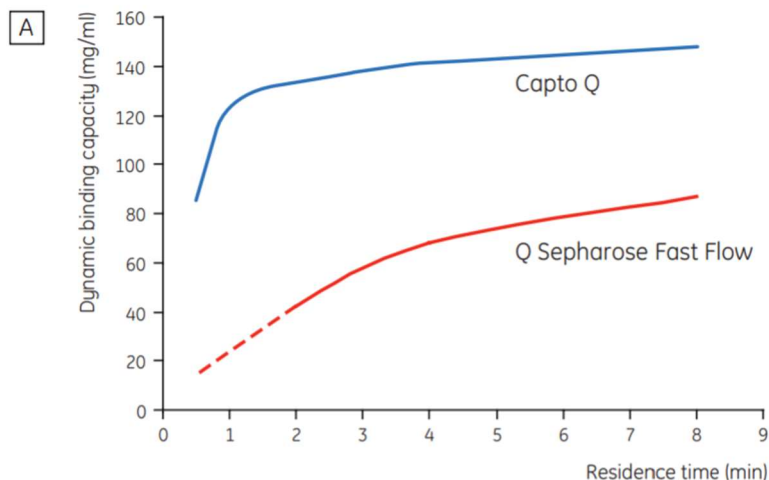

Figure 4.15. Dynamic Binding Capacities as a Function of Residence Time (GE Healthcare, 2006).

Using the assumed DBC and recommended max operating velocity of 0.117 m/min, the column specifications were calculated as follows: 0.065 L volume, 0.026 m diameter, and 0.123 m height. The column was selected as the XK 26/20 column by Cytiva, which has an adjustable bed height of up to 0.125 m and an inner diameter of 0.026 m (GE Healthcare, 2021b). The load volume was calculated to be 2.480 L using the following equation.

$$DBC_{10} = \frac{V_{load} C_F}{V_{col}}$$

Equation 4.18. Loading volume calculation from dynamic binding capacity, column volume, and concentration.

The extraparticle porosity was assumed to be 0.3, and the Carman Kozeny equation was used to calculate the column pressure as 13.933 psi, which is well within the threshold of the chosen column.

Two AEX columns will be operated simultaneously to keep the process continuous. One column will be actively purifying while the other is being cleaned and regenerated as proposed in the schedule below. The mAb concentration of the inlet and outlet streams are designed to be 3.252 g/L and 2.784 g/L respectively assuming a 90% retention of mAb.

Table 4.10. Proposed schedule anion exchange column.

Column 1	39 CV			2 CV	5 CV	5 CV	5 CV	Wait	
	Flow rate = 0.0810 L/min				Flow rate = 0.062 L/min				
	Load/Collect				Wash	Clean	Regenerate		Equilibrate
Column 2	5 CV	5 CV	5 CV	Wait	39 CV			2 CV	
	Flow rate = 0.062 L/min				Flow rate = 0.0810 L/min				
	Clean	Regenerate	Equilibrate		Load/Collect			Wash	

The proposed time breakdowns are for a total of 86.1 min with 40.95 min for loading/collecting, 2.1 min for washing, 5.25 min each for cleaning, regenerating, and equilibrating, and 27.3 min of wait time.

4.2.8 Viral Filtration

Viral filtration is the last unit operation to ensure the mAb solution is rid of small non-enveloped and larger enveloped viruses. This differs from the viral inactivation step because it uses a size exclusion membrane instead of a low pH. Viruses or virus fragments are very uncommon at this stage, but the step is necessary to meet strict FDA requirements. It also has the additional benefit of filtering antibody fragments and smaller recombinant proteins that made it through previous filtration steps. A Virosart HF mid-scale module filter with an area of 200 cm² will be used. This unit is assumed to have constant flux and no impact on protein concentration as the flow through solution will already be very pure, reducing the fouling of the filter. The following figure from Virosart indicates that the transmembrane filter will operate at a pressure of 23.451 psi at the inlet flow rate of 0.085 L/min with a constant mAb concentration of 2.784 g/L.

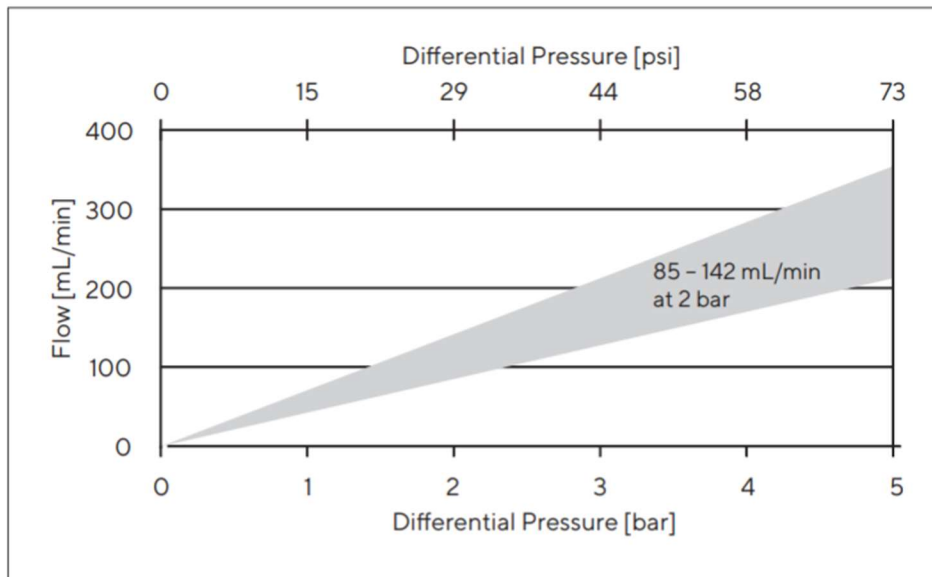

Figure 4.16. Characteristic water flow rates (Sartorius, 2020).

4.2.9 Final Ultrafiltration and Diafiltration

After viral filtration, ultrafiltration will be used to concentrate the trastuzumab solution. Ultrafiltration is a method used to concentrate a desired protein by allowing the solvent to pass through a membrane while the protein is retained and collected. Typically, the retentate is recycled and passed through the membrane multiple times to achieve the desired final protein concentration. Ultrafiltration will be performed using Cytiva AKTA flux filtration hardware (Cytiva, 2021a). This ultrafiltration unit will use 177 cm² 30 kDa PLTK MilliporeSigma Ultracel Ultrafiltration Disc filters (Fisher Scientific, 2021). These filters have the same specifications as the diafiltration modules, so the same assumptions can be applied to ultrafiltration. Trastuzumab solution will enter from viral filtration at a flow rate of 0.085 L/min and a mAb concentration of 2.78 g/L. To obtain a 99.9% protein retention, the retentate will be recycled until it exits the unit, which is operating at 10 psi, a flow rate of 0.011 L/min and a trastuzumab concentration of 21.1 g/L. The waste permeate stream will be exiting the unit at a flow rate of 0.074 L/min and a trastuzumab

concentration of 0.021 g/L. The outlet retentate solution will be passed on to the final diafiltration unit, which will exchange the solvent with WFI.

The last diafiltration step will use the same module and filters as the previous diafiltration units. However, the required pressure drop and filter area is smaller due to the reduced flow rate at this step in the downstream process. We will use twelve Pall Delta 30 kDa T-series TFF Cassettes, each with a filter area of 93 cm² for a total membrane area of 0.11 m². The pressure drop across the membrane will be 15.9 psi to ensure that 7 diavolumes will result in 99.9% buffer replacement. The stream entering the diafiltration unit will be at a flow rate of 0.011 L/min and a trastuzumab concentration of 21.1 g/L. WFI will enter the unit at a flow rate of 0.078 L/min, and the permeate waste will exit at a flow rate of 0.078 L/min and a trastuzumab concentration of 0.021 g/L. The bleed stream will exit the unit at a flow rate of 0.011 L/min and a trastuzumab concentration of 21 g/L. This final trastuzumab solution, which is sterile and safe to be given to patients, will be sent to formulation and filling where it will be given some stabilizing additives and vialled.

4.2.10 Formulation and Filling

The final formulation will have 150 mg of trastuzumab, 136.2 mg α,α -trehalose dihydrate, 3.4 mg L-histidine HCL monohydrate, 2.2 mg L-histidine, and 0.6 mg polysorbate 20. This formulation will be reconstituted in 7.4 mL of sterile water for injection on the administration site before injection for a total concentration of 21 mg/mL of mAb (Amgen, 2019). The additional ingredients prepare the trastuzumab to be properly buffered and preserved for human injection. These will be added to the stream exiting the final diafiltration, and mixed before entering lyophilization at TM-9.

Table 4.11. Additives to the final trastuzumab formulation

Ingredient	Amount Added/Campaign	
trastuzumab	10.15	kg
α,α -trehalose dihydrate	9.534	kg
L-histidine HCL monohydrate	238	mg
L-histidine	154	mg
polysorbate 20	42	mg

The amount of ingredients necessary per campaign was based on a total of 10.5 kg per campaign which is 0.35 kg more than what will be made to include a safety net in case of reduced upstream production or downstream yield. In order to increase the shelf life of our final product, as well as allow for repeated reconstitution with Bacteriostatic WFI, the final formulation will undergo lyophilization (freeze-drying).

Lyophilization works by freezing the material, then reducing the pressure and adding heat to allow the frozen water in the material to change directly to a vapor (sublimate) (“Freeze Dryer Basics,” n.d.). We will be using the Millrock QuantaS™ Sterilizable Production Freeze-Drier at largest available configuration with 16 shelves, a total shelf area of 29.73 m², and a capacity of 600 L.

4.3 Ancillary Equipment

4.3.1 Pump Design

In order to accomplish needed flow-rates for all streams, as well as pressure drops, we will be using peristaltic pumps. First seen for non-lab use in 1998, peristaltic pumps offer the safest and most economical option for transporting fluids at relatively low flow-rates (Refson & GB, 1998). Pressure drops across unit operations will also require peristaltic pumps to maintain continuous operation (Table 4.12). We will be using one pump for each stream, and assume a

pressure difference of 22 psi across all streams due to unknown stream lengths (Table 4.13). To account for power loss due to efficiency, we will assume 70% shaft efficiency and 90% driver efficiency (Eq 4.19). Our total power requirement for all pumps will be 1,323.43 W.

$$Power [W = kg \, m^2 / s^3] = Flow \, Rate [m^3 / s] * Pressure [Pa] \\ = kg / m / s^2 * Efficiency [0.63] * N_{pump}$$

Equation 4.19. Power Consumption for Peristaltic Pumps

Table 4.12. Pump Requirements for Unit Operations

Unit Operation Pressure Pumps				
Unit	Flow Rate (L/min)	Pressure (psi)	Power (W)	63% Shaft + Driver Efficiency (W)
Air Filter	216	2.1	521.262	827.400
TFF	0.435	1.66	0.830	1.317
Depth Filtration	0.081	0.35	0.033	0.052
Sterile Filtration	0.081	3.63	0.338	0.536
Protein A	0.081	0.914	0.085	0.135
VI/DF-1	0.081	38	3.537	5.615
CEX	0.057	17.6	1.153	1.830
DF-2	0.081	38	3.537	5.615
AEX	0.062	13.93	0.992	1.575
VF	0.085	23.45	2.291	3.636
UF	0.085	10	0.977	1.550
DF-3	0.011	15.9	0.201	0.319
			Total Power	849.580

Table 4.13. Pump Requirements for All Streams

Stream Pumps					
From	To	Flow Rate (L/min)	# of Pumps	Power (W)	63% Shaft + Driver Efficiency
Municipal Water	WFI Treatment	2.12	1	50.56	85.07
WFI Treatment	TH-7.1 TH-7.2	2.12	1	50.56	85.07
TH-7.1 TH-7.2	Buffer Tanks	0.193	6	27.61	46.47
TH-7.1 TH-7.2	TM-1	0.193	1	4.60	7.75
TH-7.1 TH-7.2	DF Units	0.193	3	13.80	23.24
TH-7.1 TH-7.2	TH-8	0.193	1	4.60	7.75
TH-1	TM-3	0.095	1	2.40	3.81
TH-1	TM-8	0.282	1	7.13	11.32
TH-2	TM-2	0.081	1	2.05	3.25
TH-3	TM-4	0.0165	1	0.42	0.66
TH-4	TM-5	0.033	1	0.83	1.32
TH-5	TM-6	0.095	1	2.40	3.81
TH-6	TM-7	0.058	1	1.47	2.33
TH-6	TM-8	0.22	1	5.56	8.83
TM-1	BR-1	0.255	1	6.45	10.23
BR-1	TFF	0.435	1	11.00	17.46
TFF	BR-1 Recycle	0.18	1	4.55	7.22
TFF	TW-1	0.174	1	4.40	6.98
TFF	Depth Filtration	0.081	1	2.05	3.25
Depth Filtration	Sterile Filtration	0.081	1	2.05	3.25
Sterile Filtration	Protein A	0.081	1	2.05	3.25
TM-2	Protein A	0.081	1	2.05	3.25
TM-5	Protein A	0.033	1	0.83	1.32

TM-4	Protein A	0.033	1	0.83	1.32
TM-6	Protein A	0.033	1	0.83	1.32
Protein A	TW-1	0.114	2	5.76	9.15
Protein A	Viral Inactivation	0.081	1	2.05	3.25
Viral Inactivation	DF-1	0.081	1	2.05	3.25
DF-1	TW-1	0.567	1	14.33	22.75
DF-1	CEX	0.081	1	2.05	3.25
TM-7	CEX	0.058	1	1.47	2.33
TM-8	CEX	0.139	1	3.51	5.58
CEX	TW-1	0.058	2	2.93	4.66
CEX	DF-2	0.081	1	2.05	3.25
DF-2	TW-1	0.567	1	14.33	22.75
DF-2	AEX	0.081	1	2.05	3.25
TM-3	AEX	0.062	1	1.57	2.49
TM-3	TM-4	0.0165	1	0.42	0.66
TM-8	AEX	0.081	1	2.05	3.25
TM-6	AEX	0.062	1	1.57	2.49
AEX	TW-1	0.062	1	1.57	2.49
AEX	Viral Filtration	0.085	1	2.15	3.41
Viral Filtration	UF	0.085	1	2.15	3.41
UF	TW-1	0.078	1	1.97	3.13
UF	Retentate	0.011	1	0.28	0.44
UF	DF-3	0.011	1	0.28	0.44
DF-3	TW-1	0.078	1	1.97	3.13
DF-3	TM-9	0.011	1	0.28	0.44
TH-8	TM-9	0.182	1	4.60	7.30
TM-9	Lyophilization	0.193	1	4.88	7.75
				Total Power	473.85

4.3.2 Tank Design

Tanks will be used throughout the process for holding, operation specific buffer mixing, waste storage, and emergency holding storage. All holding tanks are designed to keep $\frac{1}{4}$ of the component amount required for a 30-day campaign, and all subsequent continuous stirred tank reactors (CSTR) will hold 0.1x of the monthly requirement for each component. A system of five waste tanks will be used to collect and denature the liquid waste from various unit operations in the continuous biomanufacturing process. We will employ stainless steel tanks with single-use bags, specifically ThermoFisher HyPerforma Single-Use Mixers. Each tank will be 5000 L in order to accommodate the large volume of waste per day collected and any possible process holdups. The comprehensive list of holding and mixing tanks can be seen in Table 4.14:

Table 4.14. Tank Specifications for Holding, Mixing, and Waste Storage

Tank Identifier	Volume (L)	Type	Contents	Purpose
Upstream				
TM-1	2000	CSTR	Media, Substrate	Bioreactor Feed
TE-1	5000	Emergency	Bioreactor Contents	Emergency Holding for Bioreactor
Chromatography Buffers				
TH-1	1000	Holding	1.0 M NaCl	Holding for CEX and AEX buffers
TH-2	1000	Holding	50 mM Acetate	Holding for Protein A Elution
TM-2	500	CSTR	50 mM Acetate	Mixing for Protein A Elution
TM-3	1000	CSTR	0.1 M NaCl	Holding for Protein A Wash, Equilibrate Mixing for CEX Clean
TH-3	1000	Holding	25 mM Tris	Holding for Protein A Wash, Equilibrate
TM-4	500	CSTR	25 mM Tris + 0.1 M NaCl	Mixing for Protein A Wash, Equilibrate
TH-4	1000	Holding	0.1 M Phosphoric Acid	Holding for Protein A Regeneration
TM-5	500	CSTR	100 mM Phosphoric Acid	Mixing for Protein A Regeneration
TH-5	1000	Holding	0.1 M NaOH	Holding for Protein A Clean Holding for AEX Clean
TM-6	500	CSTR	0.1 M NaOH	Mixing for Protein A Clean Mixing for AEX Clean

TH-6	1000	Holding	50 mM Sodium Acetate	Holding for CEX Wash, Elution, Regeneration, Re-Equilibration Holding for AEX Wash, Regeneration, Equilibration
TM-7	500	CSTR	50 mM Sodium Acetate	Mixing for CEX Wash, Re-Equilibration
TM-8	500	CSTR	50 mM Sodium Acetate + 1.0 M NaCl	Mixing for CEX Elution, Regeneration Mixing for AEX Wash, Regeneration, Equilibration
TH-7.1	5000	Holding	WFI	Holding for WFI
TH-7.2	2000	Holding	WFI	Holding for WFI
TH-8	1000	Holding	α,α -trehalose dihydrate L-histidine HCL monohydrate L-histidine polysorbate 20	Holding for Final Formulation
TM-9	500	Mixing	Final Formulation	Mixing for Final Formulation
Waste				
TW-1	5000	Waste	Liquid Waste	General Waste Tank
TW-2	5000	Waste	Liquid Waste	General Waste Backup
TW-3	5000	Waste	Liquid Waste	General Waste Backup
TW-4	5000	Waste	Liquid Waste	General Waste Backup
TW-5	5000	Waste	Liquid Waste	General Waste Backup

4.4 Water for Injection (WFI) System Design

To comply with FDA safety standards, all buffers, media, and cleaning will use water for injection (WFI). The only water that comes in contact with the product must be WFI to comply with FDA regulations. WFI is nonpyrogenic, sterile, solute-free water. It must be used instead of other water to prevent possible contamination because the product will be administered to humans.

Table 4.15 below shows the WFI requirements for each process step.

Table 4.15. Water for injection (WFI) process requirements.

Process Step	WFI requirement (L)
Seed Train	1,500.00
Perfusion	37,584.00
Protein A Chromatography	958.19
Diafiltration - 1	24,505.74
Cation Exchange Chromatography	458.93
Diafiltration - 2	24,505.74
Anion Exchange Chromatography	42.16
Diafiltration - 3	3,384.85
Overall Process	91,439.61

During the seed train, 2 L/min of WFI, which is used for media, is required. During perfusion, 0.87 L/min of WFI (media) is required. During the downstream process, 1.25 L/min of WFI is required. The average flow rate of WFI required during the 30-day campaign is 2.12 L/min. To accommodate the necessary supply of water and prevent scheduling delays due to water, a 5,000 L tank and a 2,000 L tank will be used to store WFI. This can hold approximately 2.26 days' worth of required WFI during a campaign, which is ample backup WFI.

The chosen purification column to purify groundwater into WFI is the MECO Multiple Effect Distillation Column in model 4ME10. The distillate of this column has been shown to meet or exceed all GMP requirements for WFI. This model provides a flow rate of 572-591 L/hr of WFI, which is approximately 4.5 times the maximum flow rate of WFI required. It is also fast enough to refill the WFI tank in 12.24 hours (MECO, 2021). This is faster than necessary for the process, but it provides security and prevents WFI from ever backing up the process. This is important because WFI is used for all media and buffers and for cleaning, so if a production batch is lost or a contamination occurs, a large amount of WFI is required to restart the production process.

Multiple effect distillation is the most commonly used method to purify water into WFI. It can effectively create sterile, pyrogenic free WFI, and the multi-stage principle saves energy and cooling water (Bosch Packaging Technology, 2021). The MECO Multiple Effect Distillation Column comes with necessary pumps and tubing.

4.5. Air Filtration Design

To maintain product sterility, the compressed air fed to the bioreactor must be filtered and purified. Compressed air must be fed at a rate of 216 L/min (12.96 m³/h) to keep up with the oxygen demands of the cells, and the Sartopore[®] Air MidiCaps[®] size 7 filter is capable of purifying air at the necessary flow rate. The air filter must be operated at a pressure of 245 mbar, or 2.1 psi, according to Figure 4.17. This is an acceptable pressure based on designated bioreactor’s gas inlet valves (GE Healthcare, 2018c). Each individual filter has an area of 0.06 m², and the filter will be replaced after each 30-day campaign (Sartorius Stedim Biotech, 2021).

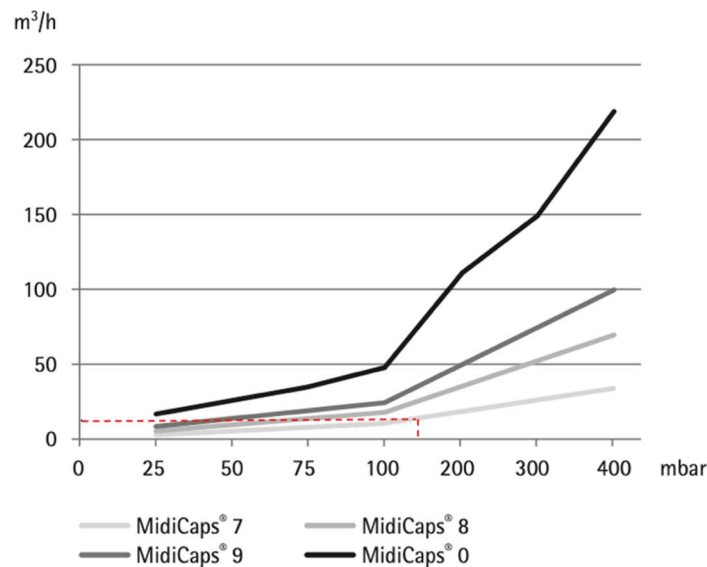

Figure 4.17. Sartopore[®] Air MidiCaps[®] flow rate capabilities (Sartorius Stedim Biotech, 2021).

4.6 Disposal

4.6.1 Liquid Waste

The liquid waste produced in each unit operation will be collected in a 5000 L holding tank, and operate in conjunction with its backup (i.e. one will be cleaned while the other is in operation). These tanks will continue to collect waste until 85% full, then will be treated with solid NaOH. NaOH is commonly used as a disinfecting and cleaning agent as it is compatible with stainless steel tanks and very effective in dissolving proteins and denaturing viruses (Heenan et al., 2005). Approximately 9.66 grams of solid NaOH will be added to a full liquid waste tank containing 4250 L of waste. This mass of NaOH was determined in order to fully neutralize the slightly acidic waste solution (the combination of all waste streams). The tank will be emptied into the Hill Canyon Wastewater Treatment Plant (HCTP) in Thousand Oaks, CA. HCTP is commonly known for its process optimization, energy management, and sustainability which is in-line with the team's goals for this facility (City of Thousand Oaks, 2021). All liquid waste will be transported by the Veolia waste management services in Southern California. Once the current waste holding tank reaches 85%, the backup tank will be entered in the process to collect the waste. Five 5000 L tanks will be cycled through the process to ensure waste treatment can be held for 5 days. The waste produced is described in Section 5.3.1.

4.6.2 Solid Waste

The solid waste produced in this manufacturing facility are the single-use reactor bags, impellers, resins, filter cartridges, and filters. Each campaign will produce approximately 566.5 kg of solid waste. Animal cell cultures, such as CHO cells, are classified as low risk biologically hazardous material, so all manufacturing equipment that comes in contact with CHO cells must

also be disposed of as biological waste. The waste from the bioreactor bags, impellers, filters, resins, and filter cartridges will be outsourced to a company that can autoclave the material then dispose of it in a landfill. Autoclaves use saturated steam under high pressure to decontaminate infectious material such as cell cultures (Hossain et al., 2012). All solid waste will be transported and treated by Veolia Waste Management Company which has a large presence in Southern California (Veolia North America, 2021).

4.7 Plant Scale Market Calculations

4.7.1 Market Analysis

Kanjinti is a biosimilar to Herceptin that treats HER2 overexpressing breast cancer and HER2 overexpressing gastric or gastroesophageal junction adenocarcinoma. It was the first Herceptin biosimilar to be launched in the United States in 2019. The wholesale price was set at \$3,697.26 per 420 mg which marked a 15% discount on the wholesale price of Herceptin (*Amgen And Allergan's MVASITM (Bevacizumab-Awwb) And KANJINTITM (Trastuzumab-Anns) Now Available In The United States*, n.d.). Other Herceptin biosimilars were on their way to approval, and now, there are currently five available in the United States. As of July 2020, Kanjinti had a market share of 33% which has been steadily rising since its launch (*US Biosimilars Trends in Oncology Therapeutics / Reports / Home - GaBI Online - Generics and Biosimilars Initiative*, n.d.). Kanjinti's share could grow in the future as it grows into its role as the biosimilar leader and as Herceptin's hold on the market is weakened over time as its first mover advantage has allowed it to dig in deeply within the healthcare system. Additionally, if Kanjinti gets approved for subcutaneous injections as well as intravenous or for other types of indications, its market size could see a sizable increase (*Analysis Of The Trastuzumab Biosimilar Market As Herceptin*

Exclusivity Nears An End, 2019). However, if other newly launched or to be launched biosimilars gain significant market share or cut prices, Kanjinti's market size could shrink. Based on its growth trajectory and established position, it may be more likely that the growth slows or flattens instead of a major dropoff. The growing adoption of biosimilars in the United States after an initial hesitancy seems to point towards a greater macro trend that favors the growth of Kanjinti's market share going forward with Kanjinti being in a unique position of significant recognition with biosimilar costs (Hagen, 2020). Though there is increasing competition from other biosimilars, Kanjinti is in a strong position to continue taking market share until a biosimilar saturated market emerges.

5. Final Design

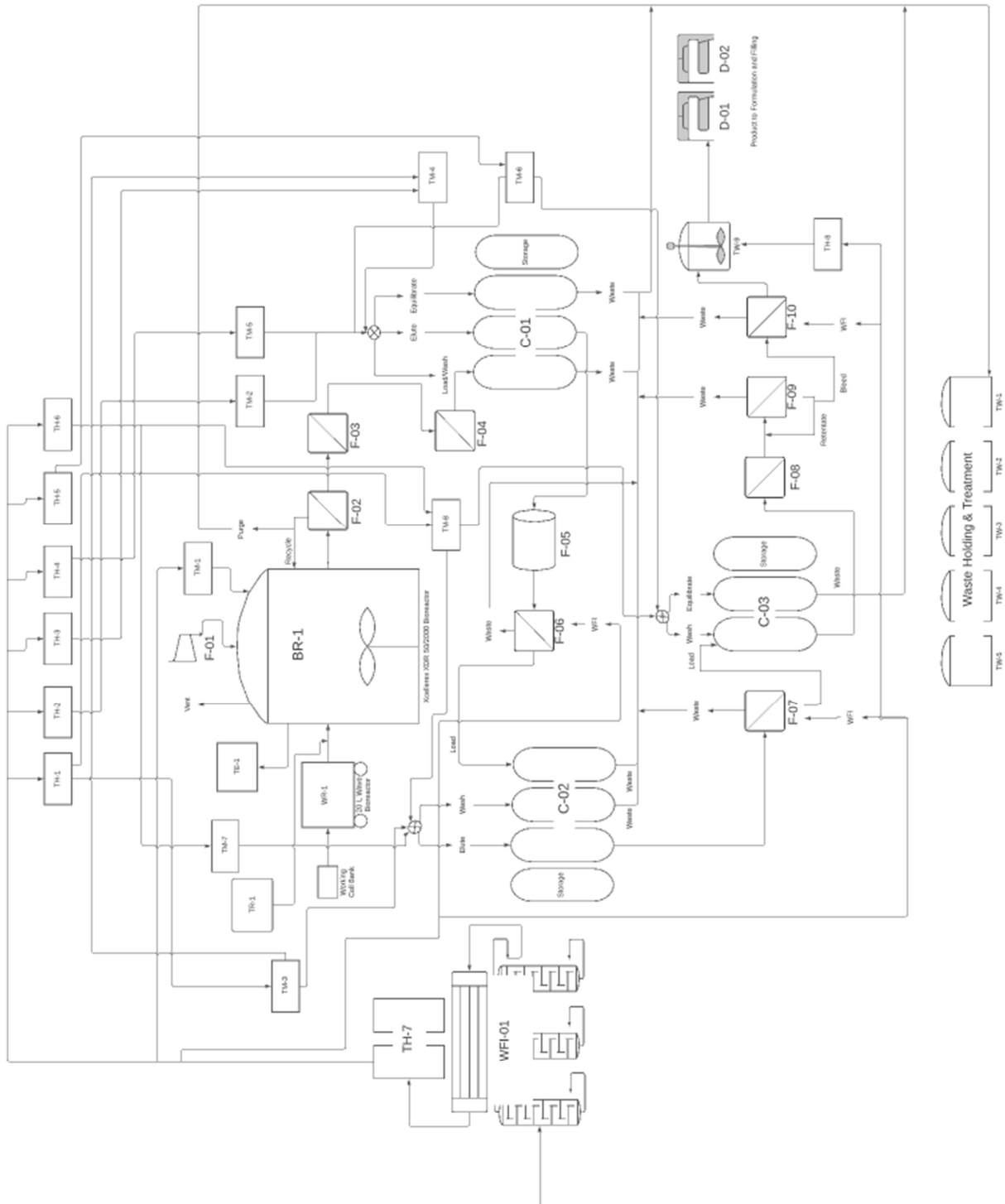

Figure 5.1. Final process flow diagram with upstream and downstream processes. Stream and equipment labels are superimposed on the diagram and detailed in Tables 5.3-5.7.

5.1 Upstream Process

5.1.1 Cell Line Acquisition and Storage

The CHO cells will be obtained from the Amgen master cell bank that is located on-site in Thousand Oaks, CA. The working cell bank for this facility will be developed from this master cell line and subsequently stored in 4.5 mL vials at a density of 50×10^6 cells/mL. Cell bank vials will be stored in a VIP Series Model MDF-U76VC-PA Freezer, which maintains a temperature of -87°C . Additionally, the Thermo Fisher Precision GP 02 water bath will be used for thawing before cells are introduced to the inoculum train (Thermo Fisher Scientific, 2021b).

5.1.2 Inoculum Train

The seed train scale-up will be performed in a 20 L wave bioreactor WR-1. Single-use reactor bags in an XDR 50/2000 bioreactor BR-1 will also be used. The beginning of the process will include 100 mL of media added to the 4.5 mL vial to suspend the cells. The initial recorded cell concentration will be 0.03 g/L. The initial substrate concentration will be 6 g/L, and the initial media concentration will be 34.92 g/L. The cell culture will be transferred to the 20 L wave bioreactor bag, and 14.9 L of media will be added to the bag. After 149.23 hours, the contents of the reactor bag will be transferred to the 400 L reactor bag. The concentration of CHO cells, substrate, and trastuzumab leaving the 15 L process will be 5.77 g/L, 2 g/L, and 1.0 g/L. Loading into the next reactor bag will be done at 2 L/min due to the pump capabilities. After adding in 385 L of media, the starting substrate concentration will return to 5.85 g/L while the concentration of CHO cells and trastuzumab will be 0.217 g/L and 0.0375 g/L, respectively. After 93.72 hours in the 400 L reactor bag (246.17 hours since the beginning of the seed train process), the broth will then be transferred to the 900 L reactor bag. The concentration of CHO cells, media, and

trastuzumab leaving the 400 L process will be 5.67 g/L, 2.05 g/L, and 0.988 g/L. After adding in 500 L of fresh media, the starting substrate concentration will return to 4.24 g/L, while the concentration of CHO cells and trastuzumab will be 2.52 g/L and 0.439 g/L, respectively. After 24.65 hours in the 900 L reactor bag (274.99 hours since the beginning of the seed train process), the broth will then be transferred to the 1500 L reactor bag. The concentration of CHO cells, substrate, and trastuzumab leaving the 900 L process will be 5.68 g/L, 2.04 g/L, and 0.989 g/L. 600 L of media will be added to return the starting concentration of CHO cells, substrate, and trastuzumab to 3.41 g/L, 3.63 g/L, and 0.593 g/L, respectively. An additional 6000 g of glucose will be added to the reactor bag to bring the substrate concentration to 7.63 g/L. The outlet concentration of CHO cells and trastuzumab leaving the 1500 L batch process and entering the perfusion process after 34.54 hours in the 1500 L reactor bag (314.52 hours since the beginning of the seed train process) will be 11.45 g/L and 1.99 g/L.

5.1.3 Perfusion Reactor

The bioreactor used for batch and perfusion mode is Cytiva's Xcellerex XDR 2000 Pro Single-use stirred-tank bioreactor. The bioreactor has an inner diameter of 123 cm, a height of 183 cm, and a total volume of 2000 L. It will be operated at 37°C and 1 atm throughout both batch and perfusion modes. The steady-state working volume will be a constant 1500 L of solution throughout the 30-day campaign. The disposable, four-blade pitched-blade impeller has a diameter of 42 cm and height of 61 cm from the bottom of the tank. The impeller will be operated at a rotational speed of 178 rpm. Compressed air will be fed to the bioreactor at an aeration rate of 0.144 vvm. With this impeller rotational speed and aeration rate, a KLa of 56.7 h⁻¹ will be achieved (well within 10% of the target value). Each 30-day campaign will alternate using one of two

perfusion reactors (both reactors are the same model and will operate under the same conditions). While one reactor is being used, the other will be shut down and prepared prior to the end of the first reactor's 30-day campaign to maintain continuous operation.

5.1.4 Tangential Flow Filtration

The TFF will be performed using the ÄKTA flux tangential flow filtration system from Cytiva with a pore size of 0.2 μm . It was assumed that 10% of the inlet solution to the TFF would pass through the membrane and be sent to depth filtration as permeate. Of this 10%, 99.9% of the mAb will pass through the membrane while retaining 99.9% of the cells. The stream from the XDR to the TFF will have a flow rate of 1.66 L/min, a cell concentration of 11.45 g/L, a glucose concentration of 1.68 g/L, and a mAb concentration of 1.99 g/L. The permeate exiting the TFF will have a flow rate of 0.081 L/min, a lysed cell concentration of 0.235 g/L, a glucose concentration of 3.44 g/L, and a mAb concentration of 4.08 g/L. The purge and recycle streams exiting from the TFF will have equal flow rates of 0.79 L/min, cell concentrations of 12.03 g/L, glucose concentrations of 1.59 g/L, and mAb concentrations of 1.89 g/L. The pressure drop of the TFF was calculated to be 1.66 psi. The permeate stream will continue to depth filtration and then to the downstream process, the purge stream will be collected in a waste tank, and the recycle stream will be sent back to the bioreactor in a continuous process.

5.1.5 Depth Filtration

The Millistak+® HC Pod Depth Filter, A1HC media series (MA1HC01FS1) will be used for depth filtration. This unit has an area of 0.11 m^2 and a length of 62 cm. The solution will flow

through the unit to downstream processing at 0.081 L/min. After each 30-day cycle, the filter will be replaced to ensure the filter is not clogged from any particulates.

5.2 Downstream Process

5.2.1 Sterile Filtration

The Sterile Millipak® - 20, 0.1 μm has an area of 0.3 m^2 and a length of 9.4 cm. The solution will flow through the unit to load the Protein A column at a flow rate of 0.081 L/min and a transmembrane pressure of 3.63 psi. After each 30-day cycle or obvious visual indications, the filter will be replaced to ensure the filter is not clogged from any particulates.

5.2.2 Protein A Chromatography

The Protein A chromatography step will use four XK 26/20 columns: three will be used during the process, and one will be held as backup. Each column, with a volume of 0.196 L will be operated at a diameter of 0.05 m and a bed height of 0.1 m. This process will be operated in flow through mode. The chosen resin is the MabSelect PrismA from Cytiva Life Sciences. The columns will operate at the recommended linear operating velocity of 100 cm/h and acceptable pressure drop of 0.914 psi. The inlet and outlet concentrations of trastuzumab are designed to be 4.07 g/L and 3.66 g/L respectively. A 0.03 g/L mAb concentration will be lost in waste. The proposed time breakdowns are for a total of 360 min with 120 min for loading and elution, and 30 min for washing, regenerating, equilibrating, and cleaning.

5.2.3 Viral Inactivation

The low pH viral inactivation will use a coiled flow inverter (CFI) plug flow reactor (PFR) custom made by Parr Instrument Company. The reactor will be designed with a linear length of 5 m, a tube diameter of 0.025 m, and a helix diameter of 0.125 m, with 2 turns per coil at 90° angles. The reactor will accept the elution stream from Protein A chromatography, which is at a flow rate of 0.081 L/min and a pH of 3.5. It is assumed that the outlet flow rate and pH will be the same as the inlet. For this design, the flow is laminar, and the residence time distribution function maintains that the fluid will spend at least half of the mean residence time in the reactor. To maintain FDA approval and patient safety, the reactor will have a mean residence time of 30 min and a minimum residence time of 15 min, which is above the 14.5 min minimum hold time proven to deactivate viruses (Mettler-Toledo International, 2021).

5.2.4 Diafiltration for Cation Exchange Chromatography

This diafiltration step will use a Cadence™ Inline Diafiltration Module to replace the 50 mM Sodium Acetate at pH of 3.5 with 50 mM Sodium Acetate at pH of 5.0. This unit will be fit with twelve 186 cm² filter cassettes: Pall Delta 30 kDa T-series TFF Cassettes (Pall Corporation, 2021b). This will provide 0.22 m² total membrane surface area. These cassettes will be replaced after each perfusion run. The inlet stream has a flow rate of 0.081 L/min and a mAb concentration of 3.66 g/L. The transmembrane pressure will be 38 psi to ensure 99.9% buffer replacement with 7 diavolumes. WFI will enter the diafiltration unit at a flow rate of 0.567 L/min, and the permeate will exit at 0.567 L/min and a mAb concentration of 0.00364 g/L. The bleed stream will exit the diafiltration unit at a flow rate of 0.081 L/min and a mAb concentration of 3.64 g/L.

5.2.5 Cation Exchange Chromatography

The cation exchange chromatography step will use four AxiChrom 50/300 columns: three will be used during the process, and one will be held as backup. Each column will be operated at a pressure of 17.6 psi, a standard diameter of 0.05 m, and a height of 0.190 m. This process will be operated in bind and elute mode. The chosen resin is the Capto S Impact Resin from Cytiva Life Sciences. The residence time is 6.5 min, and the columns will operate at the recommended linear operating velocity of 0.0293 m/min. The inlet and outlet concentrations of trastuzumab are designed to be 3.638 g/L and 3.274 g/L respectively for a step yield of 90%.

The load, wash, and re-equilibrate phases will use 50 mM sodium acetate at a pH of 5.0. These steps require 27, 5, and 5 column volumes, respectively. The elute and regenerate phases will use 50 mM sodium acetate and 1.0 M NaCl. These steps require 27 and 5 column volumes, respectively. The cleaning phase requires 5 column volumes of 0.1 M NaCl. The time breakdowns are for a total of 526.5 min with 175.5 min for loading, 32.5 min for washing, 175.5 min for eluting, 32.5 min for cleaning, regenerating, and equilibrating, and 45.5 min of wait time.

5.2.6 Diafiltration for Anion Exchange Chromatography

This diafiltration step will use a Cadence™ Inline Diafiltration Module to replace 50 mM sodium acetate buffer with WFI. This unit will be fit with twelve 186 cm² filter cassettes: Pall Delta 30 kDa T-series TFF Cassettes (Pall Corporation, 2021b). This will provide a total of 0.22 m² of membrane surface area. These cassettes will be replaced after each perfusion run. The inlet stream has a flow rate of 0.081 L/min and a mAb concentration of 3.27 g/L. The transmembrane pressure will be 38 psi to ensure 99.9% buffer replacement with 7 diavolumes. WFI will enter the diafiltration unit at a flow rate of 0.567 L/min and the permeate will exit at 0.567 L/min with a

mAb concentration of 0.00325 g/L. The bleed stream will exit the diafiltration unit at a flow rate of 0.081 L/min a mAb concentration of 3.25 g/L.

5.2.7 Anion Exchange Chromatography

The anion exchange chromatography step will use three AxiChrom XK 26/20 columns: two will be used during the process, and one will be held as backup. Each column will be operated at a pressure of 13.93 psi, a diameter of 0.026 m, and a height of 0.123 m. This process will be operated in flow through mode. The chosen resin is the Capto Q Resin from Cytiva Life Sciences. The columns will operate at the recommended linear operating velocity of 0.117 m/min. The inlet and outlet concentrations of trastuzumab are designed to be 3.252 g/L and 2.784 g/L respectively for a step yield of 90%. The wash, regenerate, and equilibrate phases will use 50 mM sodium acetate with 1.0 M NaCl. These steps require 2, 5, and 5 column volumes, respectively. The cleaning phase requires 5 column volumes of 0.1 M NaCl. The proposed time breakdowns are for a total of 86.1 min with 40.95 min for loading/collecting, 2.1 min for washing, 5.25 min for cleaning, regenerating, and equilibrating, and 27.3 min of wait time.

5.2.8 Viral Filtration

A Virosart HF mid-scale module filter with an area of 200 cm² will be operated at a pressure drop of 23.451 psi. This unit is assumed to have constant flux and no impact on protein concentration due to the purity of the flow through solution. The solution will flow at a rate of 0.085 L/min with a mAb concentration of 2.784 g/L. The filter will be replaced often (~every 8 hours) to ensure maximum purity.

5.2.9 Final Ultrafiltration and Diafiltration

The ultrafiltration will be done using a Cytiva AKTA flux filtration system with 177 cm² 30 kDa PLTK MilliporeSigma Ultracel Ultrafiltration Disc filters that are working with a pressure drop of 10 psi. These will be replaced at the end of each campaign. The trastuzumab solution will flow in at a rate of 0.085 L/min and a trastuzumab concentration of 2.78 g/L. The retentate will be continuously recycled until flowing out of the unit at a rate of 0.011 L/min and a trastuzumab concentration of 21.1 g/L to obtain 99.9% protein retention. Additionally, a waste permeate stream will flow out at a rate of 0.074 L/min and a trastuzumab concentration of 0.021 g/L. The outlet bleed solution will flow to the final diafiltration unit in which the solvent will be exchanged with WFI.

The final diafiltration will use the same module and filters as the previous diafiltration units. Twelve Pall Delta 30 kDa T-series TFF Cassettes with filter areas of 93 cm² (total membrane area of 0.11 m²) will be used at a pressure drop of 15.9 psi to replace 99.9% of the buffer in 7 diavolumes. These will be replaced at the end of each campaign. The stream from the ultrafiltration with a flow rate of 0.011 L/min and trastuzumab concentration of 21.1 g/L will be diafiltered with WFI. The WFI will enter at a flow rate of 0.078 L/min. A permeate waste stream will exit at a flow rate of 0.078 L/min and a trastuzumab concentration of 0.021 g/L. The bleed stream that will be sent to formulation and filling will exit the unit at a flow rate of 0.011 L/min and a trastuzumab concentration of 21 g/L.

5.2.10 Formulation and Filling

The final formulation for a single dose of Kanjinti has 150 mg of trastuzumab, 136.2 mg α,α -trehalose dihydrate, 3.4 mg L-histidine HCL monohydrate, 2.2 mg L-histidine, and 0.6 mg

polysorbate 20. This formulation will be reconstituted in 7.4 mL of sterile water for injection. A total of 104.87 kg of α,α -trehalose dihydrate, 2.62 kg of L-histidine HCL monohydrate, 1.69 kg of L-histidine, and 0.462 kg of polysorbate 20 will be needed each year over 11 campaigns. Before entering lyophilization, mixing of the final formula will take place in tank TM-9. The bleed stream from DF-3 will enter TM-9 at a rate of 0.011 L/min and a trastuzumab concentration of 21 g/L. The final formula will exit TM-9 at a rate of 0.011 L/min to be lyophilized.

Lyophilization will be done using the Millrock QuantaS™ Sterilizable Production Freeze-Drier at largest available configuration with 16 shelves, a total shelf area of 29.73 m², and a capacity of 600 L.

5.3 Disposal

5.3.1 Liquid Waste

The liquid waste collected from manufacturing production will be treated with NaOH as described in section 4.6.1. The total amount of liquid waste produced during each campaign is shown in Table 5.1 below.

Table 5.1. Liquid waste production

Unit Operation	Liquid Waste Produced Per Campaign (L)
Fermentation	0
Tangential Flow Filtration	68,211
Depth Filtration	0
Sterile Filtration	0
Protein A	7,002
Viral Inactivation	0
Diafiltration for Cation Exchange Chromatography	24,506
Cation Exchange Chromatography	6,094
Diafiltration for Anion Exchange Chromatography	24,506
Anion Exchange Chromatography	1,346
Viral Filtration	0
Final Ultrafiltration & Diafiltration	6,582
Total Waste	138,246

5.3.2 Solid Waste

All solid waste produced in this manufacturing process will be treated as biohazardous waste as it was in contact with biological material. The solid waste is detailed in the table below.

All mass values were taken from the respective manufacturer's website and data sheet.

Table 5.2. Solid waste produced per campaign.

Item	Quantity/Campaign	Mass per unit	Total mass per campaign (kg)	Total Mass per campaign unit
WCB cryovials	1 Vial	10.0 g	0.01	kg
TFF filters	1 Filter	0.25 kg	0.25	kg
Depth Filters	1 Filter	0.50 kg	0.5	kg
Sterile filter module	1 Module	1.0 kg	1	kg
Sterile filters	1 Filter	0.24 kg	0.24	kg
20 L bags	1 Bag	2.5 kg	2.5	kg
500 L bags	1 Bag	62.5 kg	62.5	kg
1000 L bags	1 Bag	125 kg	125	kg
2000 L bags	1 Bag	250 kg	250	kg
Chromatography Columns	11 Columns	1 kg	11	kg
Protein A resin	0.784	1000 g/L	0.784	kg
CEX resin	1.492	800 g/L	1.1936	kg
AEX resin	0.195	620 g/L	0.1209	kg
Intermediate DF filters	24 Filters	0.268 kg	6.432	kg
Viral Filtration Filters	90 Filters	0.288 kg	25.92	kg
Final DF filters	12 Filters	0.268 kg	3.216	kg
UF filters	1 Filter	0.25 kg	0.25	kg
Peristaltic tubing	3000 ft	25.2 g/ft	75.6	kg
		Total Waste	566.5	kg

5.4 Production Schedule

The proposed plant production schedule will have 11 campaigns that operate continuously. The annual production schedule is shown in Table 5.1 below. Each perfusion campaign will take approximately 30 days with an additional two weeks for scale-up as described in the process design. For the first campaign, there will be 30 days and two additional weeks for scale-up, as shown as weeks 51 and 52 in Table 5.1 For subsequent campaigns, scale-up will begin during the previous campaign, as shown in Table 5.2. Table 5.2 shows the proposed schedule for each campaign. Adequate time has been given for equipment preparation and for each process step. Table 5.1 also shows three weeks for plant shutdown. These three weeks are put into place for any maintenance and additional cleaning or to accommodate any process backup and unexpected delays. Any backup or delays will affect downstream scheduling, so the three weeks of shutdown time can serve as a buffer to keep the process continuous and to help mitigate any production losses.

Table 5.1. Yearly production schedule for trastuzumab manufacturing facility (11 campaigns).

	January				February				March				April				May				June				July				August				September				October				November				December							
Week	1	2	3	4	5	6	7	8	9	10	11	12	13	14	15	16	17	18	19	20	21	22	23	24	25	26	27	28	29	30	31	32	33	34	35	36	37	38	39	40	41	42	43	44	45	46	47	48	49	50	51	52
Campaign																																																				
1																																																				
2																																																				
3																																																				
4																																																				
5																																																				
6																																																				
7																																																				
8																																																				
9																																																				
10																																																				
11																																																				
Shutdown																																																				

Table 5.2. Production schedule for each campaign of trastuzumab production.



5.5 Equipment Tables and Specifications

5.5.1 Upstream Equipment Table

Table 5.3. Upstream equipment table

Unit Operation	Unit	Unit Number	Quantity	Temperature (°C)	Pressure Drop (psi)	Size
WCB Storage	VIP Series Model MDF-U76VC-PA Freezer	WCB-01	2	-87	n/a	728 L
Fermentation	20 L Wave Reactor	WR-01	2	37	n/a	20 L
	XDR 50/2000	BR-1	2	37	n/a	2000 L
TFF	Cytiva ÄKTA flux TFF system	F-02	2	37	1.66	A = 110 cm ² , L = 30 cm
Depth Filtration	Millistak+ ® HC Pod Depth Filters	F-03	2	Room Temp.	0.35	A = 0.11 m ² , L = 62 cm

5.5.2 Downstream Equipment Table

Table 5.4. Downstream equipment table

Unit Operation	Unit	Unit Number	Quantity	Temperature (°C)	Pressure Drop (psi)	Size
Sterile Filtration	Millipak 20 Disposable Filter Units	F-04	2	Room Temp.	3.63	D = 76 mm, L = 9.4 cm
Protein A Chromatography	Cytiva XK 50/20 column	C-01	4	Room Temp.	0.914	D = 0.5 m, L = 0.2 m
Viral Inactivation	Custom made from Parr Instrument Company	F-05	1	Room Temp.	n/a	D = 2.5 cm, L = 5.0 m
Diafiltration	Pall Delta Cadence Inline Diafiltration Module	F-06	2	Room Temp.	38.0	n/a
Cation Exchange Chromatography	AxiChrom 50/300	C-02	4	Room Temp.	17.6	D = 5.0 cm h = 19 cm
Diafiltration	Pall Delta Cadence Inline Diafiltration Module	F-07	2	Room Temp.	38.0	n/a
Anion Exchange Chromatography	XK 26/20 Column by Cytiva	C-03	3	Room Temp.	13.9	D = 2.6 cm, h = 12.3 cm
Viral Filtration	Virosart HF Mid-Scale Viral Filter	F-08	2	Room Temp.	23.5	n/a
Ultrafiltration	Cytiva ÄKTA flux TFF system	F-09	2	Room Temp.	10.0	n/a
Final Diafiltration	Pall Delta Cadence Inline Diafiltration Module	F-10	2	Room Temp.	15.9	n/a

5.5.3 Miscellaneous Equipment Table

Table 5.5 Miscellaneous Equipment Table

Unit Operation	Unit	Unit Number	Quantity	Temperature (°C)	Pressure Drop (psi)	Size (L)
Holding/Mixing	5000 L HyPerforma Single-Use Mixer	TE-1 TH-7.1 TW-1 TW-2 TW-3 TW-4 TW-5	8	Room Temp.	n/a	5000
Holding/Mixing	2000 L HyPerforma Single-Use Mixer	TM-1 TH-7.2	2	Room Temp.	n/a	2000
Holding/Mixing	1000 L HyPerforma Single-Use Mixer	TH-1 TH-2 TH-3 TH-4 TH-5 TH-6 TH-8 TM-3	9	Room Temp.	n/a	1000
Holding/Mixing	500 L HyPerforma Single-Use Mixer	TM-2 TM-4 TM-5 TM-6 TM-7 TM-8 TM-9	10	Room Temp.	n/a	500
Pumping	Welch Peristaltic Pumps	All	89	Varies	Varies	n/a
WFI	MECO Vapor Compression Distillation Module	WFI-01	1	Varies	n/a	n/a
Lyophilization	QuantaS Sterilizable Production Freeze-Drier	D-01	1	-75 to 65	25	600

5.6 Material and Energy Balances Table

5.6.1 Upstream Material Balances

Table 5.6. Upstream material balance table.

Description	From	To	Stream Flow Rate (L/min)	Material	Concentration	Units
Bioreactor	TM-1	BR-1	0.87	Glucose	6.0	g/L
	F-02	BR-1	0.79	Trastuzumab Glucose Cells	1.89 1.59 12.03	g/L g/L g/L
	BR-1	F-02	1.66	Trastuzumab Glucose Cells	1.99 1.68 11.45	g/L g/L g/L
	F-01	BR-1	216	O ₂ N ₂ CO ₂	Atmosphere	n/a
	BR-1	Vent	varies	O ₂ N ₂ CO ₂	Varies	n/a
TFF	BR-1	F-02	0.435	Trastuzumab Glucose Cells	1.99 1.68 11.45	g/L g/L g/L
	F-02	F-03	0.0810	Trastuzumab Glucose Cell Debris	4.08 3.44 0.235	g/L g/L g/L
	F-02	TW-1	0.79	Trastuzumab Glucose Cells	1.89 1.59 12.03	g/L g/L g/L
	F-02	BR-1	0.79	Trastuzumab Glucose Cells	1.89 1.59 12.03	g/L g/L g/L
Depth Filtration	F-02	F-03	0.0810	Trastuzumab Glucose Cell Debris	4.08 3.44 0.235	g/L g/L g/L
	F-03	F-04	0.0810	Trastuzumab Glucose Cell Debris	4.07 3.44 0.235	g/L g/L g/L

5.6.2 Downstream Material Balances

Table 5.7.2 Downstream material balance table.

Description	Inlet	Outlet	Stream Flow Rate (L/min)	Material	Concentration	Units
Sterile Filtration	F-03	F-04	0.0810	Trastuzumab Glucose Cell Debris	4.07 3.44 0.235	g/L g/L g/L
	F-04	C-01	0.0810	Trastuzumab Glucose Cell Debris	4.07 3.44 0.235	g/L g/L g/L
Protein A	F-04	C-01	0.0810	Trastuzumab	4.07	g/L
	TM-4	C-01	0.0810	Tris NaCl	25 100	mM mM
	C-01	TW-1	0.0810	Trastuzumab	0.204	g/L
	TM-2	C-01	0.0810	Acetate	50	mM
	C-01	F-05	0.0810	Trastuzumab	0.297	g/L
	TM-5	C-01	0.0810	H_3PO_4	100	mM
	TM-4	C-01	0.0810	Tris NaCl	25 100	mM mM
Viral Inactivation	C-01	F-05	0.0810	Trastuzumab	3.66	g/L
	F-05	F-06	0.0810	Trastuzumab	3.66	g/L
Diafiltration for CEX	F-05	F-06	0.0810	Trastuzumab	3.66	g/L
	F-06	C-02	0.0810	Trastuzumab	3.64	g/L
	TH-7.1 TH-7.2	F-06	0.567	WFI	n/a	n/a
	F-06	TW-1	0.567	Trastuzumab	3.64	mg/L
CEX	F-06	C-02	0.0810	Trastuzumab	3.64	g/L
	TM-7	C-02	0.0575	Buffer DCy*	n/a	n/a

	TM-8	C-02	0.0575	Buffer D + 1.0M NaCl	n/a	n/a
	C-02	F-07	0.0810	Trastuzumab	3.27	g/L
	TM-3	C-02	0.0575	0.1M NaCl	n/a	n/a
	TM-8	C-02	0.0575	Buffer D + 1.0M NaCl	n/a	n/a
	TM-7	C-02	0.0575	Buffer D	n/a	n/a
	C-02	TW-1	0.139	Trastuzumab Buffer D NaCl	0.209 n/a n/a	g/L n/a n/a
Diafiltration for AEX	C-02	F-07	0.0810	Trastuzumab	3.27	g/L
	F-07	C-03	0.0810	Trastuzumab	3.25	g/L
	TH-7.1 TH-7.2	F-07	0.567	WFI	n/a	n/a
	F-07	TW-1	0.567	Trastuzumab	3.25	mg/L
AEX	F-07	C-03	0.0810	Trastuzumab	3.25	g/L
	TM-8	C-03	0.0810	Buffer D	n/a	n/a
	C-03	F-08	0.0852	Trastuzumab Buffer D	2.78 n/a	g/L n/a
	TM-6	C-03	0.0619	0.1M NaOH	n/a	n/a
	TM-8	C-03	0.0619	Buffer D + 1.0M NaCl	n/a	n/a
	TM-8	C-03	0.0619	Buffer D + 1.0M NaCl	n/a	n/a
	C-03	TW-1	0.0312	Buffer D NaOH NaCl	n/a n/a n/a	n/a n/a n/a
Viral Filtration	C-03	F-08	0.0852	Trastuzumab	2.78	g/L
	F-08	F-09	0.0852	Trastuzumab	2.78	g/L

Ultrafiltration	F-08	F-09	0.0852	Trastuzumab	2.78	g/L
	F-09	F-10	0.0112	Trastuzumab	21.2	g/L
	F-09	TW-1	0.0740	Trastuzumab	21.1	mg/L
Final Diafiltration	F-09	F-10	0.0112	Trastuzumab	21.2	g/L
	F-10	TW-9	0.0112	Trastuzumab	21.0	g/L
	TH-7.1 TH-7.2	F-10	0.0784	WFI	n/a	n/a
	F-10	TW-1	0.0784	Trastuzumab	21.0	mg/L
Final Formulation	F-10	TW-9	0.0784	Trastuzumab	21.0	mg/L
	TH-8	TW-9	0.0784	α,α -trehalose dihydrate L-histidine HCl monohydrate L-histidine Polysorbate 20	19.72 $4.924 * 10^{-4}$ $3.186 * 10^{-4}$ $8.689 * 10^{-5}$	mg/L mg/L mg/L mg/L
Lyophilization	TW-9	D-01	0.1568	Trastuzumab α,α -trehalose dihydrate L-histidine HCl monohydrate L-histidine Polysorbate 20	21.0 19.72 $4.924 * 10^{-4}$ $3.186 * 10^{-4}$ $8.689 * 10^{-5}$	mg/L mg/L mg/L mg/L mg/L

*Buffer D: 50 mM sodium acetate in 1.0M NaCl

5.7 Plant Location

The manufacturing facility will be located in Thousand Oaks, California, which is the site of Amgen's headquarters. The lot is approximately 194 acres with space to build an additional manufacturing facility. The production of this facility will allow for many jobs to be created. The choice of location is economically and legally advantageous as Amgen already owns the land, and Amgen's master cell bank is already located at this facility, which we will be using for our raw materials. Thousand Oaks is also home to many other large biotechnology and biopharmaceutical

companies' headquarters, so another manufacturing facility will likely not be a concern for the general public. Similarly, there will be local talent and employees available to ensure the smooth running of this facility.

5.8 Process Economics

5.8.1 Plant Capital Costing

The fixed capital investment (FCI) is the total cost associated with constructing the plant and is a one-time cost of both direct and indirect features. These components include purchasing and installation of equipment, site remediation, development of infrastructure, construction expenses, and contingency charges. According to Peters, Timmerhaus, and West (2003), the components of fixed-capital expenditures can be broken down into percentages based on the type of chemical processing plant operated (Peters et al., 2003). The range and components of FCI are shown below in Table 5.8.

Table 5.8. Typical percentages of fixed-capital investment values for direct and indirect cost segments for multipurpose plants or large additions to existing facilities (Peters et al., 2003).

Costs	Components	Range of FCI, %
Direct Costs	Purchased Equipment	15-40
	Equipment Installation	6-14
	Instrumentation	2-12
	Piping	4-17
	Electrical	2-10
	Buildings	2-18
	Yard Improvements	2-5
	Service Facilities	8-30
	Land	1-2
Indirect Costs	Engineering and Supervision	4-20
	Construction Expense	4-17
	Legal Expenses	1-3
	Contractor's Fee	2-6
	Contingency	5-15

The table below shows the chosen percentage of fixed capital investment for each component. Each percentage was based on the specifics of this facility as well as the pharmaceutical industry in general. For instance, the lower end of purchased equipment was chosen because pharmaceutical processes typically have less large and involved equipment compared to other facilities. This same logic was applied to piping and electrical equipment. The lower end of yard improvements, service facilities, and land was chosen because the plant will be built on the Amgen headquarters campus, which the company already owns and upkeeps. Each choice for percentage of fixed capital follows similar, practical logic.

Table 5.9. Costs and chosen percentages of fixed capital investment.

Costs	Components	% of Fixed Capital	Cost
Direct Costs	Purchased Equipment	18	\$7,766,120
	Installation	8	\$3,451,609
	Instrumentation	6	\$2,588,707
	Piping	4	\$1,725,804
	Electrical	3	\$1,294,353
	Buildings	15	\$6,471,767
	Yard Improvements	2	\$862,902
	Service Facilities	10	\$4,314,511
	Land	1	\$431,451
Indirect Costs	Engineering and Supervision	12	\$5,177,413
	Construction Expense	8	\$3,451,609
	Legal Expenses	1	\$431,451
	Contractor's Fee	2	\$862,902
	Contingency	10	\$4,314,511
		Total	\$43,145,111
		Total with validation	\$44,145,111

The total capital cost was calculated by first determining the price of all the purchased equipment, both main and ancillary. The main equipment is represented by any equipment directly involved in the major unit operations on the process flow diagram, and the ancillary equipment are the machines or technologies that are used to help the main equipment function. Some examples of ancillary equipment are pumps, storage tanks, and freezers to hold the working cell bank vials. The prices and relative quantities for the main unit operations equipment are presented in Table 5.10, and the ancillary equipment is presented in Table 5.11. Almost all of the pricing for the

equipment was obtained from the respective manufacturer's website, direct price quotes from GE Healthcare sales representatives, or from reputable wholesale vendors. The viral inactivation plug flow reactor will be a custom-made piece, so the volume of steel needed was estimated then priced based on a conservative value of the price of steel per volume and mass. This value was then multiplied by 8 to account for fees and cost of construction from the Parr Instrument Company. In terms of the ancillary costs, the WFI system and storage tank pricing was obtained from a capstone project from 2020 because estimations were not able to be made from existing literature and correlations (Xu et al., 2020). The total of the main and ancillary equipment is \$7.77 million. This value was used in Table 5.9 of the percentages of fixed-capital investments to calculate the total FCI and the cost of each component of capital expenditures. The total capital cost with \$1 million for FDA validation included is \$44.1 million.

Table 5.10. Main equipment costs valued for fixed capital investment.

Unit Operation	Product	Price	Quantity	Total
Inoculation	GE Wave 25	\$75,000.00	1	\$75,000
Bioreactor	GE XDR 50/2000	\$450,000.00	2	\$900,000
TFF	GE AKTA Flux Tangential Flow System	\$33,415.00	1	\$33,415
Depth	Millistak+® HC Pod	\$15,080.00	2	\$30,160
Protein A	GE Column Holder	\$105.00	4	\$420
	GE Column Holder Rod	\$770.00	4	\$3,080
Viral Inactivation	Custom made from Parr Instrument Company	\$7,300.00	1	\$7,300
CEX DF	Pall Cadence Incline Diafiltration Module	\$5,641.00	2	\$11,282
CEX	GE Column Holder	\$105.00	4	\$420
	GE Column Holder Rod	\$770.00	4	\$3,080
AEX DF	Pall Cadence Incline Diafiltration Module	\$5,641.00	2	\$11,282
AEX	GE Column Holder	\$105.00	3	\$315
	GE Column Holder Rod	\$770.00	3	\$2,310
UF	GE AKTA Flux Tangential Flow System	\$33,415.00	2	\$66,830
Final DF	Pall Cadence Incline Diafiltration Module	\$5,641.00	2	\$11,282
			Total	\$1,156,176

Table 5.11. Ancillary equipment costs valued for fixed capital investment.

Unit Operation	Product	Price	Quantity	Total
Peristaltic Pumps	Welch Peristaltic Pump	\$1,330.00	89	\$118,370
WFI System	MECO Vapor Compression Distillation Module	\$807,288.00	1	\$807,288
Holding Tanks	5000 L HyPerforma Single-Use Mixer	\$20,000.00	9	\$180,000
	2000 L HyPerforma Single-Use Mixer	\$20,000.00	3	\$60,000
	1000 L HyPerforma Single-Use Mixer	\$20,000.00	10	\$200,000
	500 L HyPerforma Single-Use Mixer	\$20,000.00	10	\$200,000
Freezers	Panasonic Healthcare VIP Series Freezer	\$22,143.00	2	\$44,286
Freeze Drier	Millrock QuantaS Sterilizable Freeze-Drier	\$2,500,000.00	2	\$5,000,000
			Total	\$6,609,944

5.8.2 FDA Approval and Validation Costs

After 18 months of construction and engineering, the plant will enter the FDA validation phase while operating at full capacity, but not selling any trastuzumab product. This time period from start up to shut down is explicitly detailed and accounted for in Section 5.8.4 Economic Analysis using Discounted Cash Flow. The validation phase for Kanjinti is estimated to last about one year as Kanjinti is already an approved therapeutic by the FDA. In the annual operating expenses presented in Table 5.12, the laboratory charges amount to about \$484,000 per year which will ensure the upkeep in the approval process. The initial validation cost is estimated to be \$1 million, which is accounted for separately from the direct laboratory charges paid annually.

Every year the facility will endure two weeks of maintenance after Campaign 11, typically at the end of November. This maintenance will ensure there are no technical or physical issues with the process. Similarly, this shut down will fulfill the requirements of federal and state governmental agencies to prevent accidents and establish that the plant is running within the

required regulations. During this time, all equipment will be serviced and inspected as per its operational and warranty requirements.

5.8.3 Operating Expenses

The day-to-day operating expenses of this plant must be calculated before discussing the profitability or feasibility of the project. The elements that are considered annual operating costs are presented in the following table and subdivided among direct costs, fixed costs, and general costs. The methodology used to calculate the respective expenses was detailed in Turton (Turton et al., 2008). The fixed-capital investment (FCI) was calculated first, as it must be determined to calculate the remaining costs, which are weighted subject to the FCI, cost of manufacturing (COM), or respective components of the FCI. The components of FCI include raw materials, waste treatment, utilities, and operating labor.

Table 5.12. Annual operating costs.

Direct Costs	Nomenclature	Cost
Raw Materials	C_RM	\$6,449,723
Waste Treatment	C_WT	\$3,053,897
Utilities	C_UT	\$254,234
Operating Labor	C_OL	\$3,226,481
Direct, Supervisory, and Clerical Labor	0.18*C_OL	\$580,767
Maintenance and Repairs	0.06*FCI	\$779,060
Operating Supplies	.009*FCI	\$116,859
Laboratory Charges	0.15*C_OL	\$483,972
Patents and Royalties	0.03*COM	\$733,382
Fixed Costs		
Depreciation	0.1*FCI	\$1,298,434
Local Taxes and Insurance	0.032*FCI	\$415,499
Plant Overhead Costs	0.708*C_OL + 0.036*FCI	\$2,751,785
General Costs		
Administration	0.177*C_OL + 0.009*FCI	\$687,946
Distribution and Selling Costs	0.11*COM	\$2,689,067
Research and Development	0.05*COM	\$1,222,303
	Total Operating Cost	\$24,743,409
	FCI =	\$12,984,335
	COM =	\$24,446,067

Raw materials refer to the chemical feedstocks required by the process. For the case of this chemical plant, the raw materials were split into the solid's costs and constant flow costs. Solids primarily include disposable filters and chromatography resins that must be frequently replaced. The costs for these items were taken directly from the respective manufacturer's websites, trusted wholesalers, or from quotes from sales representatives. However, the price of the single-use bags, air filtration, and pharmed tubing were obtained from a 2020 capstone as we were unable to find

estimates. It is important to note that the most significant expenses from the solids in this project are the chromatography resins, especially for Protein A chromatography. The costs of the constant flows were taken directly from the respective manufacturer’s websites, mainly Sigma Aldrich. The cost of the process water was assumed to be the cost of tap water in Thousand Oaks because WFI will be made on site. Additionally, the flows of column volumes in the chromatography columns were double counted once as the given material (e.g. NaOH) and once as process water in order to make a conservative estimate. The vast majority of the constant flow cost came from the prepared media used in the bioreactor with the next highest costs being the formulation and filling flows.

Table 5.13. Solids costs.

Unit Operation	Material	Product	Quantity per Campaign (units or kg)	Price/Unit	Cost per Campaign
Wave Reactor	single-use bags	n/a	1	\$333.00	\$333.00
Fermenter	single-use bags	n/a	3	\$500.00	\$1,500.00
TFF	Filter	Millipore Sigma Ultracel UF Disc	1	\$222.00	\$222.00
Depth Filtration	Filter	Millistak+ HC Pod Depth Filter, AIHC Media Series	1	\$645.00	\$645.00
Sterile Filtration	Holder	ULTA Prime Normal Flow Filtration Capsule	1	\$249.36	\$249.36
	Filter	Millipore Sigma Millipak Disposable Filters	1	\$159.00	\$159.00
Protein A	Column	Cytiva XK 50/20	4	\$1,019.00	\$4,076.00
	Resin	Cytiva MabSelect PrismA Resin	0.784	\$18,080.00	\$14,174.72
CEX DF	Filter	Pall Delta 30 kDa T-series	12	\$446.64	\$5,359.68
CEX	Column	AxiChrom 50/300	4	\$6,660.00	\$26,640.00
	Resin	Capto S ImpAct Resin	1.492	\$3,864.00	\$5,765.09

AEX DF	Filter	Pall Delta 30 kDa T-series	12	\$446.64	\$5,359.68
AEX	Column	Cytiva XK 26/20	3	\$758.00	\$2,274.00
	Resin	Capto Q Resin	0.195	\$2,167.00	\$422.57
Viral Filtration	Filter	Sartorius Virosart HF	90	\$170.00	\$15,300.00
Ultrafiltration	Filter	Millipore Sigma Ultracel UF Disc	1	\$222.00	\$222.00
Final Diafiltration	Filter	Pall Delta 30 kDa T-series	12	\$446.64	\$5,359.68
Air Filtration	Filter	Sartorius Sartopore Capsule	1	\$343.00	\$343.00
Pumps	Tubing	Pharmed Tubing	3000	\$7.00	\$21,000.00
Storage Tanks	single-use bags	n/a	29	\$500.00	\$14,500.00
Waste Neutralization	solid NaOH	NaOH	0.516	\$102.00	\$52.63
				Total	\$123,957.41

Table 5.14. Constant flows costs.

Unit Operation	Material	Quantity per Campaign (kg or L)	Price/Unit	Cost per Campaign
Seed Train & Batch Bioreactor	Process Water	1500	\$0.00	\$2.97
	Media	1500	\$34.89	\$52,341.97
Perfusion Mode Bioreactor/TFF	Process Water	11016	\$0.00	\$21.79
	Media	11016	\$34.89	\$384,399.45
	Glucose	6	\$90.75	\$544.50
Protein A	Process Water	154.32	\$0.00	\$0.31
	Tris	0.117	\$202.00	\$23.60
	NaCl	0.225	\$67.90	\$15.31
	Acetate	0.316	\$97.40	\$30.82
	Phosphoric Acid	0.189	\$1,120.00	\$211.71
	NaOH	0.0772	\$102.00	\$7.87
CEX and DF	Process Water	24965	\$0.00	\$49.37

	NaCl	18.548	\$67.90	\$1,259.43
	Sodium Acetate	1.682	\$97.40	\$163.86
AEX and DF	Process Water	24548	\$0.00	\$48.55
	NaCl	1.739	\$67.90	\$118.10
	Sodium Acetate	0.122	\$97.40	\$11.89
	NaOH	0.050	\$102.00	\$5.06
Final UF/DF	Process Water	3384.85	\$0.00	\$6.69
Formulation and Filling	α,α -trehalose dihydrate	9.534	\$1,702.00	\$16,226.87
	L-histidine HCl monohydrate	0.238	\$697.00	\$6,645.20
	L-histidine	0.154	\$663.00	\$157.79
	polysorbate 20	0.042	\$571.00	\$87.93
			Total	\$462,381.05

As mentioned in previous sections, the waste leaving this facility is all deemed hazardous due to its contact with biologics. Appropriate disposal of waste will be done by Veolia Waste Treatment Company. It is important to note that the cost of treating hazardous material continues to rise. In order to present a conservative estimate, both the liquid and solid waste were treated as hazardous. Turton states that the average cost of hazardous waste disposal is about \$200-2,000 per tonne. Taking the high end of this range, this results in about \$0.91 per lb of hazardous waste. Per campaign, there will be 566.5 kg of solid waste and 138,247 L of liquid waste. The team assumed the liquid waste had a density of 1 kg/L which results in a total of 138,813.5 kg of waste per campaign. The cost of waste disposal and management per campaign is \$277,627 and annually is \$3.05 million. It is worth noting that the cost of NaOH used to neutralize the liquid waste is included in the cost of raw materials.

Table 5.15 below shows the power requirement of each unit operation in the process as well as the associated cost per campaign. The power consumption was calculated for each unit operation separately based on the respective manufacturers data sheets and operation manuals. For the bioreactor, the team previously calculated the power consumption in the bioreactor design section. The power consumption for the pumps was determined and detailed in Section 4.3.1. The power requirements for the holding tanks were obtained from a capstone from 2020 that had similar specifications for these unit operations (Xu et al., 2020). The cost for each piece of equipment was calculated by multiplying the amount of time each unit runs times the cost of electricity in Thousand Oaks, CA. The cost of electricity is \$0.16 per kWh (*Thousand Oaks, CA Electricity Rates*, n.d.). The cost of electricity per campaign is \$175,271 while the cost of electricity annually is \$1,927,985. The team recognizes that this value is smaller than what it should be; as it does not include rates for general utilities such as lighting, services, internet, and heating or cooling of the building.

Table 5.15. Power requirement for each unit operation.

Unit Operation	Power Requirement (kW)	Cost per Campaign
Inoculation	0.019	\$0.83
Bioreactor (Steady State)	0.280	\$32.25
TFF	0.300	\$34.52
UF	0.300	\$34.52
Pumps	1323	\$152,219.09
WFI System	2.250	\$258.88
Holding Tanks	52.20	\$6,005.92
Freezer	1.020	\$117.36
Freeze-Drier	144.0	\$16,568.06

The cost of operating labor was calculated based on Equation 5.1 which was presented in Turton et al. as a correlation obtained from five chemical companies (2008). In this equation, N_{OL} is

the number of operators per shift, P is the number of processing steps involving the handling of particulate solids, N_{NP} is the number of nonparticulate processing steps. For the purpose of this chemical plant, we determined P to be 2. This accounts for inoculation and the process of adding powdered buffers to the large holding and mixing tanks. To determine N_{NP} , all unit operations counted as one while each chromatography column also provided an additional step in the process. We determined N_{NP} to be 19. This resulted in 11.7 operators per shift.

$$N_{OL} = (6.29 + 31.7P^2 + 0.23N_{NP})^{0.5}$$

Equation 5.1. Operating labor requirement for chemical processing plant (Turton et al., 2008).

The following assumptions were obtained from Turton et al. to calculate the cost of operating labor (2008). A single operator works 49 weeks a year, with 3 weeks of total time off and sick leave. Each week the operator typically has five 8-hour shifts which adds to 245 shifts per operator per year. Since a chemical plant runs for 24 hours per day this requires 1,095 operating shifts per year resulting in approximately 4.5 operators needed per operator in the plant at any time. For this facility, 4.5 operators times 11.7 operators gives 53 operators. The average salary of a chemical plant operator in California is \$60,877, which results in an operating labor cost of \$3.23 million. This estimate only accounts for operators in the facility. All other labor costs are lumped together in the line item for direct, supervisory, and clerical labor in the annual operating expenses table.

5.8.4 Economic Analysis using Discounted Cash Flow

To calculate the project cash flows of this manufacturing facility, the general timeline must first be detailed. The plant will undergo 18 months of construction and engineering. After construction of the facility is completed, the plant will operate at full capacity for 1-year during which the firm will pay full operating costs, but the product produced will not be sold. During this

1-year period, the FDA validation process will occur simultaneously. Operating under the assumption that the FDA validation will be completed in one year, the plant will begin to operate at full capacity and sell Kanjinti 2.5 years after construction formally begins. With 2.5 years of start up and 19.5 years of operation the overall lifetime of this manufacturing facility is 22 years.

The major values used in the subsequent discounted cash flow analysis are detailed in Table 5.16 below. The initial capital cost is \$43.1 million and the FDA validation cost is \$1 million. A discount rate of 8% was used as a conservative estimate of typical pharmaceutical discount rates (Avance, 2019). The corporate tax rate in the United States is the sum of the federal government tax rate which is 21% plus that of the state in which the business is located; for this project the manufacturing facility is located in California, which has a tax rate of 8.84%. The annual operating cost is \$24.7 million, and the annual revenue is \$1.03 billion, which is based on the production of 111.7 kg of trastuzumab per year and the relative cost of \$1,388 per 150 mg vial of Kanjinti. The difference between the annual revenue and annual operating costs results in an annual profit of \$1.01 billion.

Table 5.16. Summary of important values for discounted cash flow analysis.

Initial Capital Cost	\$43,145,111
Validation Cost	\$1,000,000
Discount Rate	8.0%
Tax Rate	29.84%
Annual Operating Cost	\$24,743,409
Annual Revenue	\$1,033,597,333
Annual Profit	\$1,008,853,925

The discounted cash flow analysis is shown in Table 5.17 and Figures 5.2-5.4 below. The year-to-year cash flow was determined based on the previously described start up and operating

conditions. The taxed cash flow was calculated by applying the 29.84% corporate tax rate after the manufacturing facility begins to profit after accounting for all capital expenditures and operating costs. The discounted cash flow was calculated using Equation 5.2 below.

$$TCF_t = DCF_t (1 + i)^{-t}$$

Equation 5.2. Discounted cash flow equation.

In this equation, TCF_t is the taxed cash flow at year t , DCF_t is the discounted cash flow at year t , and i is the predetermined discount rate. Depreciation and initial capital expenditures are not explicitly seen in the following figures but are in Table 5.17. From here, the cumulative cash flow was calculated by summing together the discounted cash flow from previous years.

Table 5.17. Cash flow analysis.

Year	Cash Flow	After-tax Cash Flow	Discounted Cash Flow	Cumulative Cash Flow
0	-\$28,763,407	-\$28,763,407	-\$28,763,407	-\$28,763,407
1	-\$27,253,408	-\$27,253,408	-\$25,234,637	-\$53,998,045
2	\$479,183,554	\$336,195,181	\$288,233,180	\$234,235,136
3	\$1,008,853,925	\$712,126,425	\$565,308,916	\$799,544,051
4	\$1,008,853,925	\$712,126,425	\$523,434,181	\$1,322,978,232
5	\$1,008,853,925	\$712,126,425	\$484,661,279	\$1,807,639,511
6	\$1,008,853,925	\$712,126,425	\$448,760,443	\$2,256,399,954
7	\$1,008,853,925	\$712,126,425	\$415,518,929	\$2,671,918,883
8	\$1,008,853,925	\$712,126,425	\$384,739,749	\$3,056,658,632
9	\$1,008,853,925	\$712,126,425	\$356,240,508	\$3,412,899,141
10	\$1,008,853,925	\$712,126,425	\$329,852,323	\$3,742,751,463
11	\$1,008,853,925	\$712,126,425	\$305,418,817	\$4,048,170,280
12	\$1,008,853,925	\$712,126,425	\$282,795,201	\$4,330,965,482
13	\$1,008,853,925	\$707,811,914	\$260,260,972	\$4,591,226,453
14	\$1,008,853,925	\$707,811,914	\$240,982,381	\$4,832,208,834
15	\$1,008,853,925	\$707,811,914	\$223,131,834	\$5,055,340,669
16	\$1,008,853,925	\$707,811,914	\$206,603,550	\$5,261,944,219

17	\$1,008,853,925	\$707,811,914	\$191,299,584	\$5,453,243,803
18	\$1,008,853,925	\$707,811,914	\$177,129,244	\$5,630,373,047
19	\$1,008,853,925	\$707,811,914	\$164,008,559	\$5,794,381,606
20	\$1,008,853,925	\$707,811,914	\$151,859,777	\$5,946,241,384
21	\$1,008,853,925	\$707,811,914	\$140,610,905	\$6,086,852,288

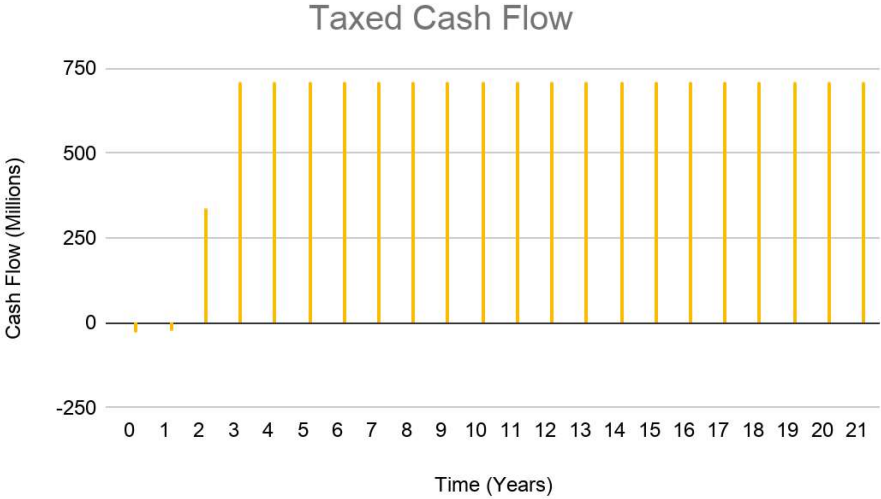

Figure 5.2. Taxed cash flow.

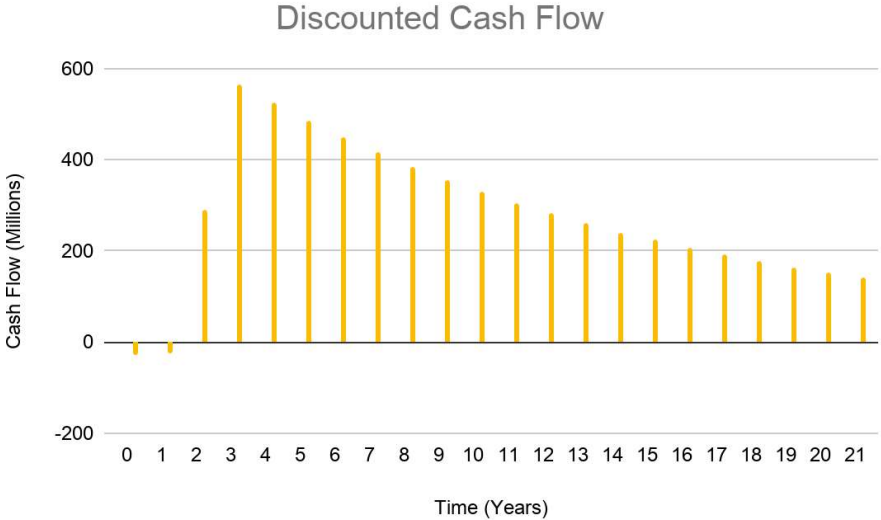

Figure 5.3. Discounted cash flow.

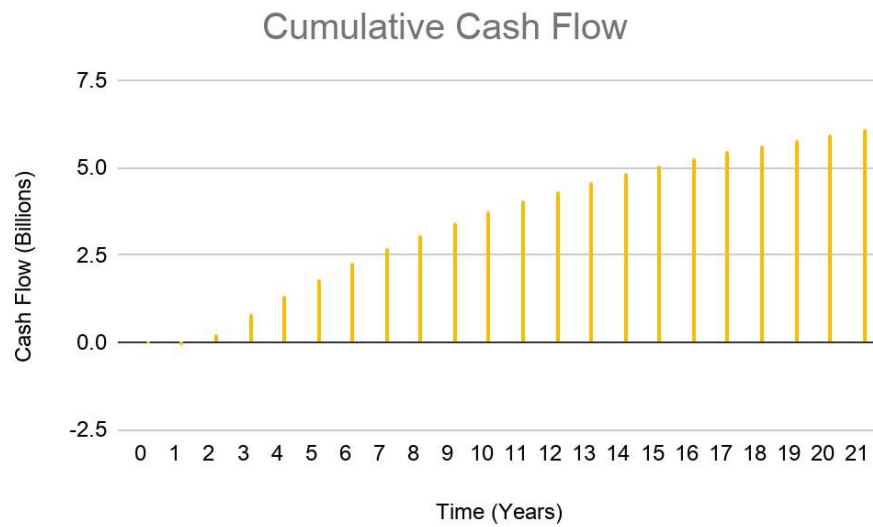

Figure 5.4. Cumulative cash flow.

The net present value of the plant at the end of year 21 was calculated to be \$30.6 billion, while the internal rate of return is 38.91%. These values were solved for using Equations 5.3a-5.3b below.

$$NPV_{21} = CCF_{21} (1 + i)^{-21}$$

$$NPV_{21} = P(1 + R)^{-21} - P(1 + i)^{-21}$$

Equations 5.3a-5.3b. Calculations for net present value and internal rate of return.

Here, NPV_{21} and CCF_{21} are the net present value and cumulative cash flow after year 21, i is the discount rate, R is the internal rate of return, and P is the initial capital expenditures or investment. The relatively high net present value and internal rate of return are good indicators of a very profitable venture.

5.8.5 Risk Analysis

Though there is data to show that the introduction of biosimilars lowers the cost of the name brand mAb, there is less data on the pricing competition between biosimilars (San-Juan-Rodriguez et al., 2019). Herceptin's biosimilars have all launched at similar price points despite

launching at separate times (Chase, 2020). However, as technology advances and competition grows, biosimilars may also experience a depression in price. Another possibility is that Kanjinti loses revenue due to loss in market share from better biosimilars being approved, manufacturing costs increasing, and other undesirable situations. While some combination of smaller factors may end up having a significant impact, the greater trends indicate that Kanjinti is in a strong position with room to grow, as reflected by the success of its launch only a few years ago. To determine the risk, case 1 in which there is a 50% reduction in revenue due to issues such as the ones mentioned above was forecasted.

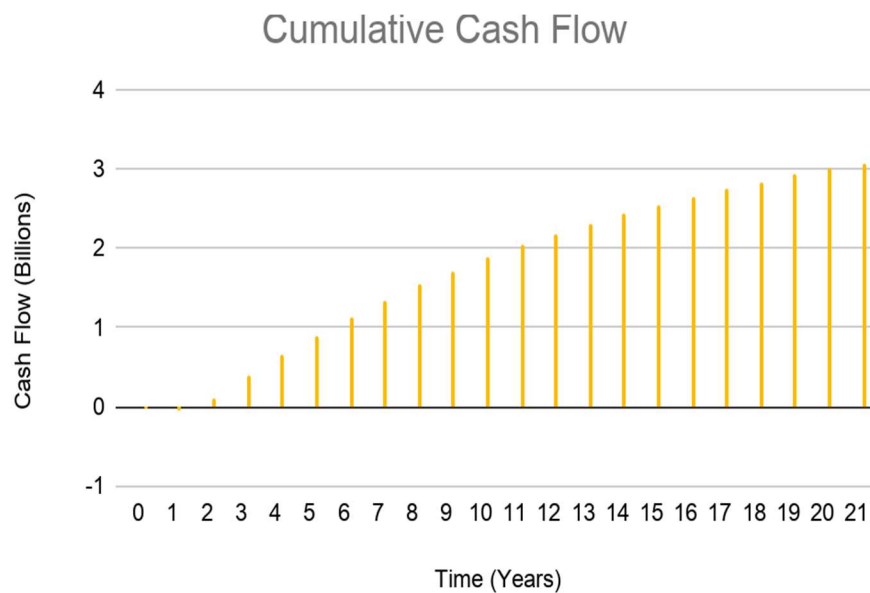

Figure 5.5. Cumulative cash flow for case 1.

Even in a drastic scenario where profits take a massive hit, the cumulative cash flow shows this project being a major success. Furthermore, the net present value and internal rate of return at \$15.5 billion and 42.85% respectively reflect the immense profitability of this project. Case 2 represents a more likely scenario in which an additional year of validation is needed and production is delayed for a year. Additionally, an assumption of one extra year for validation was used, which

is unlikely considering the biosimilar has a proven path to follow, in order to make a conservative estimate. More likely reasons for a production delay include construction issues, unexpected shutdowns, and start up issues.

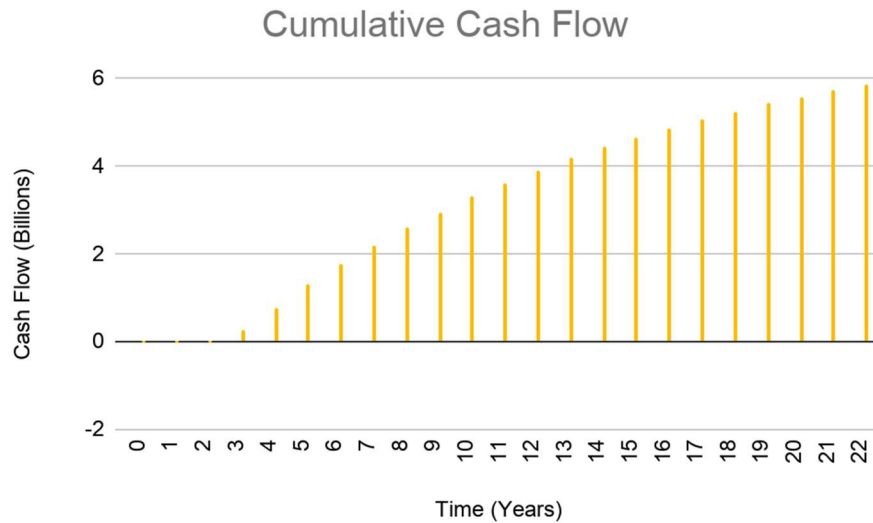

Figure 5.6. Cumulative cash flow for case 2.

In case 2, the net present value is \$29.5 billion and the internal rate of return is 47.50% which is similar to a case without issues. A combination of issues could lead to a scenario between case 1 and case 2, but would still project a successful project. Therefore, the risk on this project is relatively low barring a drastic change in the market, which is unlikely in the biologics industry due to regulations.

5.9 Quality Control

Quality control is an essential operation in the pharmaceutical industry, as drugs must be marked as both safe and therapeutically active with consistent, predictable properties and performance (Esco Technologies Inc., n.d.). Quality control is the subsection of good manufacturing practices (GMP) that deals with processes involving sampling, specifications and

testing, and organizational documentation procedures that ensure the product has not been released until the quality has been confirmed to comply with international standards (Esco Technologies Inc., n.d.). An appropriate standard operating procedure (SOP) will be developed before production begins as per FDA and GMP standards. Additionally, an in-house reference standard with known characteristics, specificity, and potency, and one that is stored under appropriate conditions, will be used for lot-to-lot comparisons by recommendation from the FDA. This manufacturing facility will have an on-site quality control lab for intermittent testing of intermediate and final products. The lab will use a combination of SDS-page, isoelectric focusing (IEF), high-pressure liquid chromatography (HPLC), mass spectrometry, and biological cell density strategies (FDA, 1997). These physicochemical methods will be used to test for molecular weight, purity, chemical identity, cell proliferation, aggregation, and fragmentation. Each test will be a valuable resource to ensure the product is performing within a predetermined range of specifications for the current location in the manufacturing process.

Testing in a continuous process tends to be more frequent than in batch manufacturing as some quality control monitoring is automated (Lee, 2019). Continuous manufacturing allows for more flexible tracking and tracing because a quantity, or “batch”, can be delineated by a timestamp, the amount of drug produced, or even the amount of raw materials inputted. This results in a more specific disposal of a “batch” if it does not pass the quality control tests in comparison to batch manufacturing. To confirm product quality and reduce waste, testing will occur every three hours before and after multiple unit operations. The locations for sampling will be leaving the perfusion bioreactor, post sterile filtration, post Protein A chromatography, post cation exchange chromatography, post anion exchange chromatography, and post the final ultrafiltration and diafiltration step. If the “batch” fails the testing standards, all material produced in that three-hour

window will be disposed of in accordance with FDA and GMP regulations. After the disposal of this “batch”, the product will be tested every hour for the next twenty-one hours to confirm the return of smooth operations. Finally, a root cause analysis will be conducted, and if there is a major issue present the process will be stopped and emergency holding tanks will be used to hold the uncontaminated product (FDA, 1997).

Because quality control is so essential for the safety, efficacy, and monetary value of this operation, all personnel will be properly trained for each stage in the manufacturing process that affects the properties of the drug produced. Training will include basic concepts, such as personal protective equipment (PPE), and complex protocols of aseptic technique, which is the practices and procedures that prevent contamination from pathogens (Esco Technologies Inc., n.d.).

6. Regulatory, Safety, Health, and Environmental Considerations

To comply with all FDA procedures and standards, this manufacturing facility will operate under the guidelines of the Current Good Manufacturing Practices (CGMPs). CGMPs are standards enforced by the FDA that set regulations for proper design, monitoring, and control of manufacturing processes. Following the CGMP will ensure the product is of the correct identity, strength, quality, and purity to be given to patients. Some of these regulations will include implementing strong management systems, obtaining high quality raw materials, establishing strict operating procedures, investigating product differentiations, and maintaining reliable staff and testing equipment (FDA, 2019a).

The safety hazards associated with the production of trastuzumab originate from caustic cleaning chemicals, biological agents, and buffers used in downstream processing. All personnel on site must wear proper PPE, undergo safety training, and comply with CGMP guidelines as

defined by the Occupational Safety and Health Administration (OSHA) and FDA per their job function. In the case of a global pandemic such as COVID-19, all employees must abide by CDC guidelines such as social distancing and wearing a mask. The chemicals that provide some safety hazards are NaOH, HCl, NaCl, and sodium acetate. All four chemicals are caustic, so they are able to burn or corrode organic tissue upon contact. This presents a health hazard in the downstream process of this facility, specifically at all stages of chromatography and intermediate diafiltration unit operations. The facility will have emergency shower and eyewash stations in the event that personnel are directly exposed to the caustic chemicals. All personnel will also be trained to identify non-chemical risks such as those from utility units, mechanical equipment, and transportation vehicles such as trucks or forklifts. For these reasons, the site will be designed to account for unusual operating conditions such as loss of power or an emergency start up/shut down.

The environmental footprint of the plant is primarily from the solid, liquid, and biological waste produced from both upstream and downstream processes. The disposable single-use reactor bags used in the seed train will produce solid plastic waste. However, this waste plastic, after being sterilized, will be transported for off-site recycling. Implementation of single-use reactor bags has had a positive impact on the environment in comparison to traditional bioprocesses, which include the use of more caustic chemicals for cleaning as stated in a GE Healthcare study (Morrow, 2019). This would impose additional environmental and safety issues that can be avoided with the use of reactor bags. As discussed, all liquid waste will be disposed of according to municipal waste disposal regulations. Specifically, NaOH and HCl used in cleaning and buffer solutions will be treated with 1.0 M NaOH to deactivate the biologics in the system and then neutralized with 1.0 M HCl when necessary. The actual construction of this facility should have a small effect on the

parking and traffic patterns because it will be located on an already constructed Amgen headquarters campus.

7. Social and Ethical Concerns

Social and ethical concerns should always be considered in any manufacturing process, especially in the pharmaceutical industry, as patients rely on these therapeutics to improve their quality of life. Furthermore, large pharmaceutical companies typically undergo scrutiny from the public, who claim that they are a profit driven industry with minimal regard to their patients in terms of drug pricing and accessibility. For this reason, Kanjinti will be produced in a way to optimize both drug pricing and accessibility to ensure Amgen remains an industry leader. Other issues that should be considered are the plant environment and the work-life balance of the employees. The focus on these issues will ensure overall success for the patients receiving this treatment, Amgen, and those affected by the manufacturing facility.

The effort to produce trastuzumab using continuous biotechnology was prioritized due to its cost and time saving benefits. For more than 50 years, pharmaceuticals have been produced using the lengthy, multi-step process known as batch manufacturing, which uses large-scale equipment. After each step in the batch process, production is halted so samples can be tested. This results in large stopping times, potential product degradation, and the possibility of losing a significant amount of product if the batch does not meet FDA requirements (Lee, 2019). In continuous manufacturing, material is fed nonstop through the same facility and hold times are eliminated. This method saves time, reduces the possibility of human error, and can respond to potential needs for scale-up. For example, if there is a higher demand present, the facility can run for a longer period of time to reduce the likelihood of drug shortages. Continuous manufacturing

may also allow for more precise tracking and tracing in the event of product failure. This reduces the amount of product that may have to be thrown out. Overall, the more efficient and cost-effective continuous processing will allow for Kanjinti to be marketed at a lower price than other competitors, encouraging patients to get treatment rather than suffering due to the monetary burden. Similarly, the drug will be more accessible as continuous processing reduces the waste and shortage issues in the event of process or product failure (Lee, 2019).

The environmental impact on both residents living near the plant and employees at the plant should be considered when discussing the social and ethical implications of our project. Some of the potential impacts to the local community will be noise from construction, an increase in jobs for skilled workers, and potential traffic congestion. However, the impact should not be too significant because the Amgen headquarters in Thousand Oaks, CA neighbors many other large pharmaceutical manufacturing sites and relatively few residential communities. Similarly, waste will not be an issue because it will be disposed of in a manner that minimizes environmental impact. The upstream process in the bioreactor takes advantage of single-use reactor bags that have proven to be less harmful to the environment than the typical means of stainless-steel equipment. Although single-use bags produce plastic waste, it is relatively insignificant compared to the global quantity of plastic used for packaging (Morrow, 2019). In the biotechnology industry, this plastic waste must be managed according to strict regulations, so it will not end up negatively impacting the environment. The continuous process also seeks to improve the efficiency of the plant while decreasing the amount of natural resources the plant requires. All employees will undergo a safety and ethics training program before they begin on-site work at the plant. Employees will also be provided benefits and a competitive salary in congruence with their experience and job function.

8. Conclusions and Recommendations

This report demonstrates the profitability, practicality, and effectiveness of producing a trastuzumab biosimilar using single-use and continuous technology. The proposed manufacturing facility would allow for a more-efficient production process by operating under a completely continuous schedule. Despite the risks surrounding contamination, continuous operation is beneficial for reducing production time, costs, and personnel. In addition, single-use technology will reduce the time and costs associated with equipment cleaning and maintenance.

By reducing production time and costs, this manufacturing facility would not only increase profitability on Amgen's Kanjinti product, but also reduce costs to patients who suffer from HER2+ breast cancer. The proposed Kanjinti manufacturing process would reduce the cost of treatment by more than 18% compared to the name-brand Herceptin treatment. By lowering the price of treatment, we expect that Amgen would capture 17% of the global trastuzumab market by producing 111.7 kg Kanjinti each year. Based on our economic analysis, Amgen's investment in this manufacturing facility would be highly profitable, with the project's net present value being \$30.6 billion and an internal rate of return of 38.91% for 21 years of operation.

It is our recommendation that Amgen moves forward with the proposed project. Given the consistent high demand of trastuzumab, this manufacturing facility will be a feasible and financially viable long-term investment. In terms of validation, we recommend constructing a pilot plant to compare the design calculations with actual process performance. The pilot plant will be important for identifying any design issues or unforeseen problems, as well as for determining final yield of the actual process. As with all plant designs, there are inherent risks associated with safety and product quality. However, our research suggests that the proposed manufacturing facility is ready for validation and construction.

9. Acknowledgement

The team would like to express our sincere gratitude to the University of Virginia School of Engineering and Applied Sciences for all the knowledge and opportunities given to us over the past four years, without which this capstone project would not have been possible. We would like to thank Professor Eric Anderson, Professor George Prpich, and Professor Giorgio Carta for their help throughout the last year. Professor Anderson was monumental in the completion of this project, as he ensured we stuck to our proposed project schedule while ameliorating any issues that arose quickly and efficiently. Professor Prpich and Professor Carta provided their expertise in their relevant subject areas of upstream and downstream processing. Finally, the team would like to thank the University of Virginia community, family, and friends for providing us with resources and support to successfully complete this capstone project and fulfill our dreams of being students here.

10. Table of Nomenclature

Equation No. - 1st appearance	Symbol	Definition	Unit
4.1	$K_L a$	Mass Transfer Coefficient	h^{-1}
	q_{O_2}	Oxygen Consumption Rate	mmol/g-h
	X	Cell Concentration	g/L
	$C_{O_2}^*$	Solubility of Oxygen at 37°C, 1 atm	mg/L
	C_{O_2}	Minimum Oxygen Concentration	mg/L
4.2	Re	Reynolds Number	dimensionless
	N	BR-1 Impeller Rotational Speed	rpm
	D_i	BR-1 Impeller Diameter	cm
	ρ	BR-1 Solution Density	kg/m^3
	μ	Dynamic Viscosity	$kg/m*s$
4.3	P	BR-1 Power Requirement	W
	N_P	BR-1 Power Number	dimensionless

	D_t	BR-1 Tank Diameter	cm
4.4	N_a	BR-1 Aeration Number	dimensionless
	Q_g	BR-1 Aeration Rate	vvm
4.5	P_g	BR-1 Power Input	W
4.6	D	Cell Dilution Rate	h^{-1}
	F_0	Fresh Media Flow Rate	L/h
	V	BR-1 Working Volume	L
4.7	μ_{max}	Maximum Cell Growth Rate	h^{-1}
	K_s	Half-Velocity Constant	g/L
	S	Substrate Concentration	g/L
	a	Concentration Factor	dimensionless
	b	Recycle Ratio	dimensionless
	X_r	Cell Concentration of BR-1 recycle stream	g/L

	X_I	Cell Concentration entering F-02	g/L
	F_r	BR-1 Recycle Flow Rate	L/h
4.8	$Y_{X/S}$	Cell Yield Coefficient	g cell/g substrate
4.9	$D_{washout}$	Washout Dilution Rate	h^{-1}
	S_0	Initial Substrate Concentration	g/L
4.11	Q	Flow Rate across F-02	Various, as long as Re remains dimensionless
	d	F-02 Membrane Fiber Diameter	Various, as long as Re remains dimensionless
	ν	Kinematic Viscosity	Various, as long as Re remains dimensionless
	f	Reduced Reynolds Number	dimensionless
	ΔP	Pressure Drop	psi
	L	F-02 Flow Path Length	cm
4.12	De	Dean Number	dimensionless
	λ	Inversion Ratio	dimensionless

4.13	$E(t)$	Residence Time Distribution	n/a
	t	Time spent in F-05	min
	τ	F-05 Residence Time	min
4.14	U_{max}	Maximum Flow Velocity through F-05	m/min
	U_{avg}	Average Flow Velocity through F-05	m/min
4.16	DBC_{10}	Dynamic Binding Capacity for 10% Breakthrough	mg/mL
	C_F	C-02 Load Concentration	mg/mL
4.17	ϵ	Chromatography Extraparticle Porosity	dimensionless
	d_p	Chromatography Particle Diameter	mm
	η	Dynamic Viscosity	Pa*s
4.19	N_{pump}	# of pumps	Natural Number
5.1	N_{OL}	# of operators/shift	Natural Number
	P	# of particulate processing steps	Natural Number
	N_{NP}	# of nonparticulate processing steps	Natural Number
5.2	TCF_t	Taxed cash flow at year t	USD

	DCF_t	Discounted cash flow at year t	USD
	i	Interest rate	%
5.3	NPV_{21}	Net present value at end of 21st year	USD
	CCF_{21}	Cumulative cash flow at end of 21st year	USD
	P	Initial capital expenditures	USD
	R	Internal Rate of Return	%

11. References

- Akel, S. (2015). Chapter 3 - Cell Banking: Process Development and Cell Preservation. In A. Atala & J. G. Allickson (Eds.), *Translational Regenerative Medicine* (pp. 21–37). Academic Press. <https://doi.org/10.1016/B978-0-12-410396-2.00003-7>
- Amgen. (2019). *Highlights of Prescribing Kanjinti*. Amgen Inc. https://www.accessdata.fda.gov/drugsatfda_docs/label/2019/761073s000lbl.pdf
- Amgen And Allergan's MVASI™ (bevacizumab-awwb) And KANJINTI™ (trastuzumab-anns) Now Available In The United States*. (n.d.). Amgen. Retrieved April 12, 2021, from <https://www.amgen.com/newsroom/press-releases/2019/07/amgen-and-allergans-mvasi-bevacizumabawwb-and-kanjinti-trastuzumabanns-now-available-in-the-united-states>
- Analysis Of The Trastuzumab Biosimilar Market As Herceptin Exclusivity Nears An End*. (2019, April 23). <https://www.biosimilardevelopment.com/doc/analysis-of-the-trastuzumab-biosimilar-market-as-herceptin-exclusivity-nears-an-end-0001>
- Avance. (2019). *Discount Rates for Biotech Companies*.
- Blankenship, K. (2020, July 27). *12. Herceptin*. FiercePharma. <https://www.fiercepharma.com/special-report/top-20-drugs-by-global-sales-2019-herceptin>
- Bosch Packaging Technology. (2021). *Multiple-Effect Distillation Unit*. <https://www.pharmaceuticalonline.com/doc/multiple-effect-distillation-unit-0001>
- Carta, G. (2020). *Membrane Based Separations*. https://collab.its.virginia.edu/access/content/group/0cfe6c95-bbbc-4e58-93d0-20309c169879/Lecture%20slides/4_Membrane_Based_Separations_2020.pdf
- Cation Exchange Chromatography | LSR | Bio-Rad*. (n.d.). Retrieved March 1, 2021, from

- <https://www.bio-rad.com/en-us/applications-technologies/cation-exchange-chromatography?ID=MWHB018UU>
- CDC - *Expected New Cancer Cases and Deaths in 2020*. (2019, January 31).
https://www.cdc.gov/cancer/dcpc/research/articles/cancer_2020.htm
- Chase, L. (2020, April 14). *Biosimilar Prices: How Much They Cost and How to Save - GoodRx*. The GoodRx Prescription Savings Blog. <https://www.goodrx.com/blog/biosimilar-prices-how-much-they-cost-how-to-save/>
- City of Thousand Oaks. (2021). *Hill Canyon Treatment Plant | Thousand Oaks, CA*.
<https://www.toaks.org/departments/public-works/operations/hill-canyon-treatment-plant>
- Clincke, M.-F., Mölleryd, C., Zhang, Y., Lindskog, E., Walsh, K., & Chotteau, V. (2013). Very High Density of CHO Cells in Perfusion by ATF or TFF in WAVE Bioreactor™. Part I. Effect of the Cell Density on the Process. *Biotechnology Progress*, 29(3), 754–767.
<https://doi.org/10.1002/btpr.1704>
- Cytiva. (2020). *Xcellerex XDR Cell Culture Bioreactor Systems*. Cytiva.
<https://cdn.cytivalifesciences.com/dmm3bwsv3/AssetStream.aspx?mediaformatid=10061&destinationid=10016&assetid=23694>
- Cytiva. (2021a). *AKTA flux tangential flow filtration system*. Cytiva.
<https://www.cytivalifesciences.com/en/us/shop/bioprocessing-filtration/tangential-flow-filtration/filtration-systems/akta-flux-tangential-flow-filtration-system-p-05755>
- Cytiva. (2021b). *MabSelect Prisma A protein A chromatography resin*. Cytiva.
<https://www.cytivalifesciences.com/en/us/shop/chromatography/resins/affinity-antibody/mabselect-prisma-protein-a-chromatography-resin-p-09659>
- Davis, M. E., & Davis, R. J. (2003). *Fundamentals of chemical reaction engineering*. McGraw-

- Hill Higher Education. <https://doi.org/10/FundChemReaxEngCh9.pdf>
- de Taeye, S. W., Rispens, T., & Vidarsson, G. (2019). The Ligands for Human IgG and Their Effector Functions. *Antibodies*, 8(2). <https://doi.org/10.3390/antib8020030>
- Esco Technologies Inc. (n.d.). *Quality Control / In-Process Quality Control*. Retrieved March 28, 2021, from <http://www.escopharma.com/solutions/quality-control-in-process-quality-control>
- FDA. (1997). *Points to Consider in the Manufacture and Testing of Monoclonal Antibody Products for Human Use*. U.S. Department of Health and Human Services. <https://www.fda.gov/files/vaccines%2C%20blood%20%26%20biologics/published/Points-to-Consider-in-the-Manufacture-and-Testing-of%09Monoclonal-Antibody-Products-for-Human-Use.pdf>
- FDA. (2019a). Facts About the Current Good Manufacturing Practices (CGMPs). *FDA*. <https://www.fda.gov/drugs/pharmaceutical-quality-resources/facts-about-current-good-manufacturing-practices-cgmps>
- FDA. (2019b). Implementation of the Biologics Price Competition and Innovation Act of 2009. *FDA*. <https://www.fda.gov/drugs/guidance-compliance-regulatory-information/implementation-biologics-price-competition-and-innovation-act-2009>
- Fisher Scientific. (2021). *MilliporeSigma Ultracel Ultrafiltration Disc—Filters and Filtration, Ultrafiltration Filters and Devices*. <https://www.fishersci.com/shop/products/emd-millipore-ultracel-ultrafiltration-disc-39/p-3206997>
- Freeze Dryer Basics: What Is a Freeze Dryer and How Does It Work? (n.d.). *Millrock Technology, Inc.* Retrieved April 15, 2021, from <https://www.millrocktech.com/lyosight/lyobrary/what-is-a-freeze-dryer/>

GE Healthcare. (2006). *Capto Q, Capto ViralQ, Capto S*. General Electric Company.
<https://www.cytivalifesciences.co.jp/newsletter/downstream/pdf/11002576ad.pdf>

GE Healthcare. (2014). *Ion Exchange Chromatography Capto S Impact*. General Electric Company. <https://www.cytivalifesciences.co.jp/catalog/pdf/29067018ABDF.pdf>

GE Healthcare. (2015). *One-step seed culture expansion from one vial of high-density cell bank to 2000 L production bioreactor*. General Electric Company.
<https://www.cytivalifesciences.co.kr/wp-content/uploads/2020/04/One-step-seed-culture-expansion-from-one-vial-of-high-density-cell-bank-to-2000-L-production-bioreactor.pdf>

GE Healthcare. (2016). *Ion Exchange Chromatography Principles and Methods*. General Electric Company.
<https://cdn.cytivalifesciences.com/dmm3bwsv3/AssetStream.aspx?mediaformatid=10061&destinationid=10016&assetid=13101>

GE Healthcare. (2018a). *Efficient clean-in-place methods for protein-based antibody affinity chromatography resins*. General Electric Company.
<https://cdn.cytivalifesciences.com/dmm3bwsv3/AssetStream.aspx?mediaformatid=10061&destinationid=10016&assetid=24266>

GE Healthcare. (2018b). *Perfusion culture using TFF or ATF cell retention method*. General Electric Company.

GE Healthcare. (2018c). *Xcellerex XDR-50 to 2000 Bioreactor Systems Operating Instructions*. General Electric Company.

GE Healthcare. (2021a). *Capto Q ion exchange chromatography resin*. Cytiva.
<https://www.cytivalifesciences.com/en/us/shop/chromatography/prepacked-columns/ion-exchange/capto-q-ion-exchange-chromatography-resin-p-00599>

GE Healthcare. (2021b). *XK columns*. Cytiva.

<https://www.cytivalifesciences.com/en/us/shop/chromatography/columns/empty-columns-for-lab-scale/xk-columns-p-06322>

General Kinematics. (2017). Batch vs. Continuous Pharmaceutical Manufacturing. *General Kinematics*. <https://www.generalkinematics.com/blog/batch-vs-continuous-pharmaceutical-manufacturing/>

George Prpich. (2020, April). *Lecture 17: Oxygen Transfer*.

Goudar, C. T., Piret, J. M., & Konstantinov, K. B. (2011). Estimating cell specific oxygen uptake and carbon dioxide production rates for mammalian cells in perfusion culture. *Biotechnology Progress*, 27(5), 1347–1357. <https://doi.org/10.1002/btpr.646>

Hagen, T. (2020, October 19). *Mvasi, Kanjinti Add Heft to Amgen's Third-Quarter Sales*. The Center For Biosimilars. <https://www.centerforbiosimilars.com/view/mvasi-kanjinti-add-heft-to-amgen-s-third-quarter-sales>

Heenan, M., Looby, M., McGowan, S., Cullen, S., & Moran, E. (2005). Biowaste management during biopharmaceutical plant start-up: From regulatory guidance to verified inactivation methods. *Biopharm International*, 18, 70–76.

Hossain, Md. S., Balakrishnan, V., Rahman, N. N. N. A., Sarker, Md. Z. I., & Kadir, M. O. A. (2012). Treatment of Clinical Solid Waste Using a Steam Autoclave as a Possible Alternative Technology to Incineration. *International Journal of Environmental Research and Public Health*, 9(3), 855–867. <https://doi.org/10.3390/ijerph9030855>

Lee, S. (2019). Modernizing the Way Drugs Are Made: A Transition to Continuous Manufacturing. *FDA*. <https://www.fda.gov/drugs/news-events-human-drugs/modernizing-way-drugs-are-made-transition-continuous-manufacturing>

- Li, L., Kumar, S., Buck, P., Burns, C., Lavoie, J., Singh, S., Warne, N., Nichols, P., Luksha, N., & Boardman, D. (2014). Concentration Dependent Viscosity of Monoclonal Antibody Solutions: Explaining Experimental Behavior in Terms of Molecular Properties. *Pharmaceutical Research*, 31. <https://doi.org/10.1007/s11095-014-1409-0>
- Liu, H. F., Ma, J., Winter, C., & Bayer, R. (2010). Recovery and purification process development for monoclonal antibody production. *MAbs*, 2(5), 480–499. <https://doi.org/10.4161/mabs.2.5.12645>
- Lu, R.-M., Hwang, Y.-C., Liu, I.-J., Lee, C.-C., Tsai, H.-Z., Li, H.-J., & Wu, H.-C. (2020). Development of therapeutic antibodies for the treatment of diseases. *Journal of Biomedical Science*, 27(1), 1. <https://doi.org/10.1186/s12929-019-0592-z>
- Mayer, B. K., Yang, Y., Gerrity, D. W., & Abbaszadegan, M. (2015). The Impact of Capsid Proteins on Virus Removal and Inactivation During Water Treatment Processes. *Microbiology Insights*, 8(Suppl 2), 15–28. <https://doi.org/10.4137/MBI.S31441>
- McKinney, N. (2018). *Cryopreservation of Cells*. USPC. <https://www.usp.org/sites/default/files/usp/document/our-work/biologics/resources/gc-1044-cryopreservation-of-cells.pdf>
- MECO. (2021). Multiple Effect Distillation Stills | Pharmaceutical Grade Water. *MECO*. <https://www.meco.com/product/biopharmaceuticals-multiple-effect-stills/>
- Mettler-Toledo International. (2021). *Viral Inactivation in Bioprocessing*. https://www.mt.com/us/en/home/applications/L1_AutoChem_Applications/fermentation/viral-inactivation-in-bioprocessing.html
- Millipore. (2003). *Protein Concentration and Diafiltration by Tangential Flow Filtration*. Millipore Corporation. https://www.bio-link.org/sites/files/tff_technical_brief.pdf

Millipore. (2004). *Millipak Disposable Filter Units*. Millipore Corporation.

<http://www.evsemi.com/file%20pdf/Technical%20Specifications%20Millipore%20Millipak%20100.pdf>

Millipore. (2019). *Millistak+® HC Pod Depth Filter, A1HC media series, 0.11 m² surface area* |

MA1HC01FS1. https://www.emdmillipore.com/US/en/product/Millistak+-HC-Pod-Depth-Filter-A1HC-media-series-0.11m2-surface-area,MM_NF-MA1HC01FS1#anchor_DS

Morrow, J. (2019, March 12). Addressing Challenges Posed by the Adoption of Single-Use Systems. *GEN - Genetic Engineering and Biotechnology News*.

<https://www.genengnews.com/topics/bioprocessing/how-should-companies-deal-with-single-use-accumulated-plastic-waste/>

Mukherjee, S. (2011). *The Emperor of All Maladies: A Biography of Cancer* (Reprint edition). Scribner.

Pall Corporation. (2021a). *Cadence™ Inline Diafiltration Module—Single-Pass TFF* | *Pall Shop*.

<https://shop.pall.com/us/en/biotech/continuous-processing/in-line-diafiltration/zidgri66603>

Pall Corporation. (2021b). *T-Series TFF Cassettes—Delta* | *Pall Shop*.

<https://shop.pall.com/us/en/biotech/tangential-flow-filtration/cassettes/zidgri78m0j>

Panasonic Healthcare Corporation. (2016). *VIP Series Ultra-Low Temperature Upright Freezer*.

<http://en.esbe.com/Customr/esscin/specpages/MDF-U76VC-U76VA-PA.pdf>

Peters, M. S., Timmerhaus, K. D., & West, R. E. (2003). *Plant Design and Economics for Chemical Engineers*. McGraw-Hill Education.

Prpich, G. (2019). *Chemostat with Cell Recycle*.

- Rathore, A., Nigam, K. D. P., Pathak, M., Agarwal, H., Sharma, A. K., Kateja, N., & Hebhi, V. (2016). *A coiled flow inverter reactor for continuous refolding of denatured recombinant proteins and other mixing operations* (World Intellectual Property Organization Patent No. WO2016116947A1). <https://patents.google.com/patent/WO2016116947A1/en>
- Refson, B. H., & GB. (1998). *United States Patent: 5846064 - Peristaltic pump* (Patent No. 5846064). <http://patft.uspto.gov/netacgi/nph-Parser?Sect1=PTO2&Sect2=HITOFF&p=1&u=%2Fnetacgi/nph-bool.html&r=3&f=G&l=50&co1=AND&d=PTXT&s1=5846064&OS=5846064&RS=5846064>
- Rossi, D., Gargiulo, L., Valitov, G., Gavriilidis, A., & Mazzei, L. (2017). Experimental characterization of axial dispersion in coiled flow inverters. *Chemical Engineering Research and Design*, 120, 159–170. <https://doi.org/10.1016/j.cherd.2017.02.011>
- San-Juan-Rodriguez, A., Gellad, W. F., Good, C. B., & Hernandez, I. (2019). Trends in List Prices, Net Prices, and Discounts for Originator Biologics Facing Biosimilar Competition. *JAMA Network Open*, 2(12), e1917379. <https://doi.org/10.1001/jamanetworkopen.2019.17379>
- Sartorius. (2020). *Virosart® HF: High-Speed Virus Filtration for MABs and Recombinant Proteins Product Information*. Sartorius Stedim Biotech GmbH. <https://www.sartorius.com/shop/medias/-datasheet-en-Data-Virosart-HF-Capsule-Family-SPK2180-e.pdf?context=bWFzdGVyfGRvY3VtZW50c3wxMjMzNzgwfGFwcGxpY2F0aW9uL3BkZnxkb2N1bWVudHMvaDk2L2g1Ny84OTY5MjA1OTczMDIyLnBkZnxhOWM0ZWQ5ZTdkYTI5ZGE5MDUzN2ZjZGUxN2MxZWZhYmE0OTcwZTdiYjQzZmM3YmVIYz>

UyMzU2MzA3MGVjNzcx

Sartorius Stedim Biotech. (2021). *Sartopore Air MidiCaps and MaxiCaps*.

Schwartz, L. N. (2003). *Diafiltration: A Fast , Efficient Method for Desalting , or Buffer Exchange of Biological Samples*. /paper/Diafiltration-%3A-A-Fast-%2C-Efficient-Method-for-%2C-or-Schwartz/4abf20e19a144bd233ac93e52e3b0391210b8f89

Tao, Y., Shih, J., Sinacore, M., Ryll, T., & Yusuf-Makagiansar, H. (2011). Development and implementation of a perfusion-based high cell density cell banking process. *Biotechnology Progress*, 27(3), 824–829. <https://doi.org/10.1002/btpr.599>

Thermo Fisher Scientific. (2020). *High-Intensity Perfusion CHO Medium*.

https://www.thermofisher.com/document-connect/document-connect.html?url=https%3A%2F%2Fassets.thermofisher.com%2FTFS-Assets%2FLSG%2Fmanuals%2FMAN0019412_High-IntensityPerfusionCHO_Medium_UG.pdf&title=VXNlciBHdWlkZTogSGlnaC1JbnRlbnNpdHkgUGVyZnVzaW9uIENITYBNZWRpdW0=

Thermo Fisher Scientific. (2021a). *Gibco High-Intensity Perfusion CHO Medium—US*.

<https://www.thermofisher.com/us/en/home/life-science/bioproduction/gibco-bioprocessing/cho-media/gibco-perfusion-medium.html>

Thermo Fisher Scientific. (2021b). *Precision™ General Purpose Baths*. Thermo Scientific.

<https://www.thermofisher.com/order/catalog/product/TSGP02>

Thousand Oaks, CA Electricity Rates. (n.d.). Electricity Local. Retrieved April 13, 2021, from

<https://www.electricitylocal.com/states/california/thousand-oaks/>

Trastuzumab. (n.d.). Drug Bank. Retrieved October 8, 2020, from

<https://go.drugbank.com/drugs/DB00072>

- Turton, R., Bailie, R. C., Whiting, W. B., & Shaeiwitz, J. A. (2008). *Analysis, Synthesis and Design of Chemical Processes*. Pearson Education.
- University of Michigan. (2017). *Chapter 13 Summary Notes*.
<http://www.umich.edu/~elements/fogler&gurmen/html/course/lectures/thirteen/index.htm>
- US biosimilars trends in oncology therapeutics / Reports / Home—GaBI Online—Generics and Biosimilars Initiative*. (n.d.). Retrieved April 12, 2021, from
<https://www.gabionline.net/Reports/US-biosimilars-trends-in-oncology-therapeutics>
- Veolia North America. (2021). *Hazardous Waste Stabilization and Landfill Services*. Veolia North America. <https://www.veolianorthamerica.com/what-we-do/waste-capabilities/hazardous-waste-stabilization-and-landfill-services>
- Watson Marlow Fluid Technology Group. (2021). *313 and 314 OEM pumpheads*.
<https://www.wmftg.com/en-ie/range/watson-marlow-pumps/oem-pumps/oem-cased/300oem/313-314/>
- What is Herceptin® (trastuzumab) for HER2+ Cancer?* (n.d.). Herceptin. Retrieved October 6, 2020, from <https://www.herceptin.com/patient/about-herceptin.html>
- Wurm, F. M. (2004). Production of recombinant protein therapeutics in cultivated mammalian cells. *Nature Biotechnology*, 22(11), 1393–1398. <https://doi.org/10.1038/nbt1026>
- Xu, S., Burruss, C., Mohan, R., Rushin, N., & Abt, B. (2020). *Design of a Pembrolizumab Manufacturing Plant Using Continuous Bioprocess Technology and Single-Use Bioreactors*. University of Virginia.
- Xylem. (2019). *Dissolved Oxygen Tables*.
<https://www.yisi.com/file%20library/documents/technical%20notes/do-oxygen-solubility-table.pdf>

Yavorsky, D., Blanck, R., Lambalot, C., & Brunkow, R. (2003). The clarification of bioreactor cell cultures for biopharmaceuticals. *Pharmaceutical Technology*, 27, 62–76.

Zhang, Y., Ye, L., Zhang, B., Chen, Y., Zhao, W., Yang, G., Wang, J., & Zhang, H. (2019).

Characteristics and performance of PVDF membrane prepared by using NaCl coagulation bath: Relationship between membrane polymorphous structure and organic fouling.

Journal of Membrane Science, 579, 22–32. <https://doi.org/10.1016/j.memsci.2019.02.054>