



EVOLVE

# LED Roadway Lighting

ERLC-ERL1-ERL2



Current 



CUSTOMER NAME \_\_\_\_\_

PROJECT NAME \_\_\_\_\_

DATE \_\_\_\_\_ TYPE \_\_\_\_\_

CATALOG NUMBER \_\_\_\_\_

The Evolve® LED Roadway ERLC Luminaire is optimized utilizing advanced LED reflective optical system for local, collector and major roadways. The modern design incorporates the heat sink directly into the unit for heat transfer to prolong LED life.

### Construction

<b>Housing:</b>	Aluminum die cast enclosure casting integral heat sink for maximum heat transfer
<b>Lens:</b>	Impact resistant tempered glass
<b>Paint:</b>	Corrosion resistant powder paint, ≥ 2.0 mil thickness (RAL & custom colors available) Standard = Black, Dark Bronze, Gray, White Optional = Coastal Finish
<b>Weight:</b>	8.5 lbs (5.6 kgs)

### Optical System

<b>Lumens:</b>	2,000 - 7,000
<b>Distribution:</b>	Type II Narrow, II/III <sup>3</sup> , III, V
<b>Efficacy:</b>	110-143 LPW
<b>CCT:</b>	2700K, 3000K, 4000K & 5000K
<b>CRI:</b>	≥ 70

### Electrical

<b>Input Voltage:</b>	120-277V (no 347-480V)
<b>Input Frequency:</b>	50/60Hz
<b>Power Factor:</b>	≥ 90% at rated watts
<b>Total Harmonic Distortion:</b>	≤ 20% at rated watts

### Surge Protection\*

STANDARD	OPTIONAL
10kV/5kA	Secondary 10kV/5kA (R Option) or Secondary 20kV/10kA (T Option)

\*Per ANSI C136.2-2018

### Lumen Maintenance

#### Projected Lxx per IES TM-21-11 at 25°C

LUMEN CODES	DISTRIBUTIONS	LXX(10K) @ HOURS		
		25,000 HR	50,000 HR	60,000 HR
02, 03, 04, 05	A5, B5, C5	L97	L93	L92
06	A5, B5, C5	L96	L91	L89

LUMEN CODES	DISTRIBUTIONS	LXX(10K) @ HOURS		
		25,000 HR	50,000 HR	60,000 HR
02, 03, 04, 05	V4	L96	L93	L93
06	V4	L94	L90	L88

### Ratings

<b>Operating Temperature:</b>	-40°C to 50°C
<b>Vibration:</b>	3G per ANSI C136.31-2018
<b>LM-79:</b>	Testing in accordance with IES Standards
<b>EMI:</b>	Title 47 CFR Part 15 Class A
<b>RoHS:</b>	Complies with the material restrictions of RoHS

### Controls

<b>Dimming:</b>	Standard - 0-10V Optional - DALI (Option U)
<b>Sensors:</b>	Photo Electric Sensors (PE) available LightGrid Compatible

### Warranty

5 Year (Standard)

10 Year (Optional)

Not all product variations listed on this page are DLC qualified. Visit [www.designlights.org/search](http://www.designlights.org/search) to confirm qualifications.



### Ordering Information

## ERLC

PROD. ID	VOLTAGE <sup>1</sup>	LUMENS	DISTRIBUTION	CCT	CONTROLS PER ANSI C136.41	COLOR	OPTIONS
E = Evolve	0 = 120-277V <sup>1</sup>	02=2000 lm <sup>2</sup>	A5 = II Narrow	27 = 2700K <sup>4</sup>	A = 7-Pin Receptacle	BLCK = Black	B = Tether
R = Roadway	8 = 120-240V	03=3000 lm	B5 = Type II/III <sup>3</sup>	30 = 3000K <sup>4</sup>	D = 7-Pin Receptacle with Shorting Cap	DKBZ = Dark Bronze	C1 = Captive Door
L = Local		04=4000 lm	C5 = Type III	40 = 4000K	E = 7 Pin Receptacle with Long Life non-Dimming PE Control	GRAY = Gray	F = Fusing
C = Compact	1 = 120V	05=5000 lm	V4 = Type V	50 = 5000K	Note: 0-10V control standard unless DALI Option "U" requested	WHITE= White	G = Internal Bubble Level
	2 = 208V	06=6000 lm					L = Tool-Less Entry
	3 = 240V	07=7000 lm					M1 = MagnaPak <sup>8</sup>
	4 = 277V						R = Secondary 10kV/5kA SPD T = Secondary 20kV/10kA SPD U = DALI Programmable <sup>5</sup> V1 = Field Adjustable Module <sup>17</sup> Y = Coastal Finish <sup>6</sup> XXX = Special Options

<sup>1</sup> Not Available with Fusing

<sup>2</sup> Lumen choice only offered for 120-240V

<sup>3</sup> See ISO plots of the B5 Distribution

<sup>4</sup> Select 2700K or 3000K CCT for IDA approved units

<sup>5</sup> Compatible with LightGrid

<sup>6</sup> Recommended for installations within 750 feet from coast. Lead time varies, check with factory.

<sup>7</sup> Not available with DALI "U" option

<sup>8</sup> Option M1 provides for MagnaPak – 40 Fixtures per MagnaPak Container. Single Pack box is standard

### Suggested HID Replacement

- Approximately 2,000 - 7,000 lumens to replace 50-100W HPS Cobra-head

Note: actual replacement lumens may vary based upon mounting height, pole spacing, design criteria, etc.

PREVIOUS	OPTICAL PATTERN	LATEST	NEW OPTICAL PATTERN
A3	Type II Narrow	A5	Type II Narrow
B3	Type II Wide	B5	Type II/III
C3	Type III	C5	Type III
N/A	Type V	V4	Type V

The information above is designed to provide a guideline to select the correct luminaire for a roadway application. The best and most accurate way to ensure the proper design is by doing a lighting layout.



Not all product variations listed on this page are DLC qualified. Visit [www.designlights.org/search](http://www.designlights.org/search) to confirm qualifications.

CUSTOMER NAME \_\_\_\_\_

PROJECT NAME \_\_\_\_\_

DATE \_\_\_\_\_ TYPE \_\_\_\_\_

CATALOG NUMBER \_\_\_\_\_

LUMEN OUTPUT	DIST.	LUMENS			WATTAGE	BUG RATINGS		
		4000K/5000K	3000K	2700K	120-277V	4000K/5000K	3000K	2700K
02	A5	2000	1940	1760	15	B1-U0-G1	B1-U0-G1	B1-U0-G1
	B5	2000	1940	1760	15	B1-U0-G1	B1-U0-G1	B1-U0-G1
	C5	2000	1940	1760	15	B1-U0-G1	B1-U0-G1	B1-U0-G1
	V4	1990	1950	1890	15	B1-U0-G0	B1-U0-G0	B1-U0-G0
03	A5	3000	2910	2640	22	B1-U0-G1	B1-U0-G1	B1-U0-G1
	B5	3000	2910	2640	22	B1-U0-G1	B1-U0-G1	B1-U0-G1
	C5	3000	2910	2640	22	B1-U0-G1	B1-U0-G1	B1-U0-G1
	V4	3100	3030	2950	23	B1-U0-G0	B1-U0-G0	B1-U0-G0
04	A5	4000	3880	3520	28	B1-U0-G1	B1-U0-G1	B1-U0-G1
	B5	4000	3880	3520	28	B1-U0-G1	B1-U0-G1	B1-U0-G1
	C5	4000	3880	3520	28	B1-U0-G1	B1-U0-G1	B1-U0-G1
	V4	4030	3940	3840	32	B2-U0-G0	B2-U0-G0	B2-U0-G0
05	A5	5000	4850	4400	36	B1-U0-G1	B1-U0-G1	B1-U0-G1
	B5	5000	4850	4400	36	B1-U0-G1	B1-U0-G1	B1-U0-G1
	C5	5000	4850	4400	36	B1-U0-G2	B1-U0-G2	B1-U0-G1
	V4	5200	5090	4950	43	B2-U0-G1	B2-U0-G1	B2-U0-G1
06	A5	6000	5820	5280	46	B2-U0-G2	B1-U0-G1	B1-U0-G1
	B5	6000	5820	5280	46	B1-U0-G2	B1-U0-G2	B1-U0-G2
	C5	6000	5820	5280	46	B1-U0-G2	B1-U0-G2	B1-U0-G2
	V4	6350	6220	6050	55	B2-U0-G1	B2-U0-G1	B2-U0-G1
07	A5	7000	6790	6160	56	B2-U0-G2	B2-U0-G2	B2-U0-G2
	B5	7000	6790	6160	56	B1-U0-G2	B1-U0-G2	B1-U0-G2
	C5	7000	6790	6160	56	B1-U0-G2	B1-U0-G2	B1-U0-G2

For additional information on ERLC IES files, please click one of the following links:

[Non-Shielded](#)

[Shielded](#)

**ERLC**  
**Type II Narrow**

5,000 Lumens  
4000K  
ERLC\_05A540\_\_\_IES

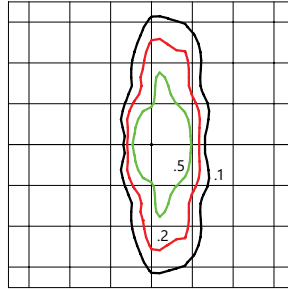

- Mounting Height at 30'
- Initial Footcandle at Grade

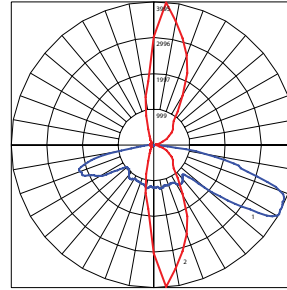

- Vertical plane at max Cd horiz. angle
- Horizontal cone at max Cd vert. angle

**ERLC**  
**Type II/III<sup>3</sup>**

5,000 Lumens  
4000K  
ERLC\_05B540\_\_\_IES

<sup>3</sup> This optic is designed to address a Roadway Photometric Application and may classify as Type II or III.

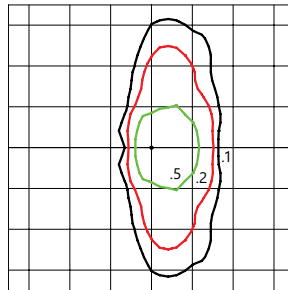

- Mounting Height at 30'
- Initial Footcandle at Grade

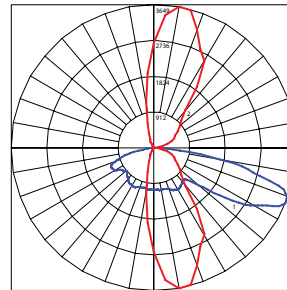

- Vertical plane at max Cd horiz. angle
- Horizontal cone at max Cd vert. angle

**ERLC**  
**Type III**

5,000 Lumens  
4000K  
ERLC\_05C540\_\_\_IES

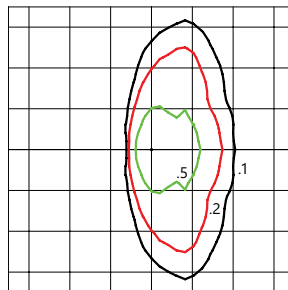

- Mounting Height at 30'
- Initial Footcandle at Grade

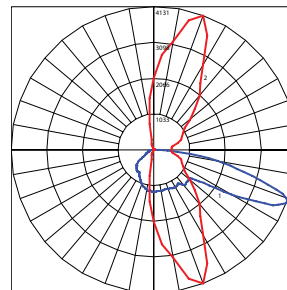

- Vertical plane at max Cd horiz. angle
- Horizontal cone at max Cd vert. angle

**ERLC**  
**Type V**

5,200 Lumens  
4000K  
ERLC\_05V440\_\_\_IES

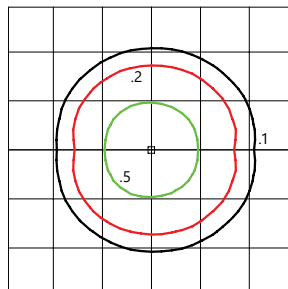

- Mounting Height at 30'
- Initial Footcandle at Grade

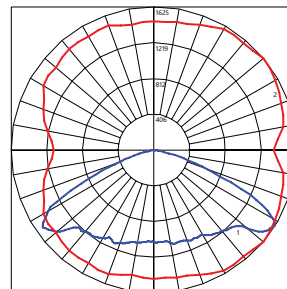

- Vertical plane at max Cd horiz. angle
- Horizontal cone at max Cd vert. angle

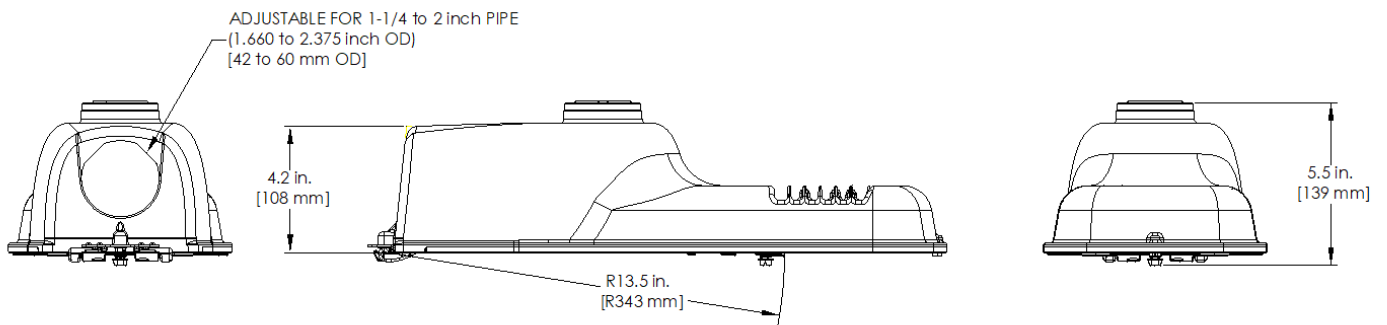
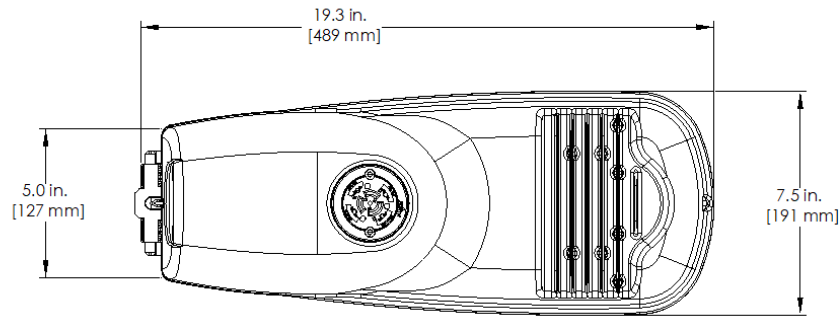

### Mounting

- Adjustable for 1.25 to 2 in. nominal mounting pipe
- Integral diecast mounting pipe stop
- Slipfitter with +/- 5 degrees of leveling adjustment

### Effective Projected Area

- 0.3 sq ft max (0.029 sq m)

### Weight

- Approximate net weight: 8.5 lbs (3.8 kgs)

### Accessories

SAP NUMBER	PART NUMBER	DESCRIPTION
93029237G	PED-MV-LED-7	ANSI C136.41 Dimming PE, 120-277V
93029238G	PED-347-LED-7	ANSI C136.41 Dimming PE, 347V
93029239G	PED-480-LED-7	ANSI C136.41 Dimming PE, 480V
28299	PEC0TL	Standard 120-277V
XXXXXX	PECHTL	Standard 347-480V
73251	SCCL-PECTL	Shorting Cap

See pages 22 & 23 for more detailed information on ERLC Shields.

### Networked Lighting Control



Current's **LightGrid™** Outdoor Lighting Control System is designed for Street and Roadway Applications. It enables remote monitoring, control, and asset management of a single fixture or a group of fixtures through a web enabled Central Management System.



CUSTOMER NAME \_\_\_\_\_

PROJECT NAME \_\_\_\_\_

DATE \_\_\_\_\_ TYPE \_\_\_\_\_

CATALOG NUMBER \_\_\_\_\_

The Evolve® LED Roadway ERL1 Luminaire is optimized utilizing advanced LED reflective optical system for local, collector and major roadways. The modern design incorporates the heat sink directly into the unit for heat transfer to prolong LED life.

### Construction

<b>Housing:</b>	Aluminum die cast enclosure casting integral heat sink for maximum heat transfer
<b>Lens:</b>	Impact resistant tempered glass
	Corrosion resistant powder paint, $\geq 2.0$ mil thickness
<b>Paint:</b>	(RAL & custom colors available) Standard = Black, Dark Bronze, Gray, White Optional = Coastal Finish
<b>Weight:</b>	12.4 lbs (5.6 kgs)

### Optical System

<b>Lumens:</b>	2,000 - 15,700
<b>Distribution:</b>	Type II ,III, IV, Type II Narrow and Type II Enhanced Backlight
<b>Efficacy:</b>	111-140 LPW
<b>CCT:</b>	2700K, 3000K, 4000K and 5000K
<b>CRI:</b>	$\geq 70$

### Electrical

<b>Input Voltage:</b>	120-277V or 347-480V
<b>Input Frequency:</b>	50/60Hz
<b>Power Factor:</b>	$\geq 90\%$ at rated watts
<b>Total Harmonic Distortion:</b>	$\leq 20\%$ at rated watts

### Surge Protection\*

STANDARD	OPTIONAL
10kV/5kA	Secondary 10kV/5kA (R Option) or Secondary 20kV/10kA (T Option)

\*Per ANSI C136.2-2018

### Lumen Maintenance

Projected Lxx per IES TM-21-11 at 25°C

LUMEN CODES	DISTRIBUTIONS	LXX(10K) @ HOURS		
		25,000 HR	50,000 HR	60,000 HR
02, 03, 04, 05, 06	A5, B5, C5, D5, E5	L96	L94	L93
07, 08	A5, B5, C5, D5, E5	L99	L98	L98
09	A5, B5, C5, D5, E5	L98	L97	L96
10	A5, B5, C5, D5, E5	L94	L87	L84
11	A5, B5, C5, D5, E5	L93	L85	L82
12	A5, B5, C5, D5, E5	L96	L95	L94
13	A5, B5, C5, D5, E5	L96	L94	L93
14	A5, B5, C5, D5, E5	L95	L92	L91
15	A5, B5, C5, D5, E5	L93	L88	L86
16	A5, B5, C5, D5, E5	L91	L85	L83

Note: Projected Lxx based on LM80 ( $\geq 10,000$  hour testing). Accepted industry tolerances apply to initial luminous flux and lumen maintenance measurements.

### Ratings

<b>Operating Temp:</b>	-40°C to 50°C
<b>Vibration:</b>	3G per ANSI C136.31-2018
<b>LM-79:</b>	Testing in accordance with IES Standards
<b>EMI:</b>	Title 47 CFR Part 15 Class A
<b>RoHS:</b>	Complies with the material restrictions of RoHS

### Controls

<b>Dimming:</b>	Standard-0-10V Optional-DALI (Option U)
<b>Sensors:</b>	Photo Electric Sensors (PE) available LightGrid Compatible

### Warranty

5 Year (Standard)

10 Year (Optional)



CUSTOMER NAME \_\_\_\_\_

PROJECT NAME \_\_\_\_\_

DATE \_\_\_\_\_ TYPE \_\_\_\_\_

CATALOG NUMBER \_\_\_\_\_

### Ordering Information

## ERL1

PROD. ID	VOLTAGE	LUMENS	DISTRIBUTION <sup>3</sup>	CCT	CONTROLS PER ANSI C136.41	COLOR	OPTIONS
E = Evolve	0 = 120-277V <sup>1,2</sup>	02 = 2000 lm <sup>2</sup>	A5 = Type II Narrow	27 = 2700K <sup>4</sup>	A = 7-Pin Receptacle	GRAY = Gray	A = 4 Bolt Slipfitter <sup>5</sup>
R = Roadway	H = 347-480V <sup>1</sup>	03 = 3000 lm	B5 = Type II	30 = 3000K <sup>4</sup>	D = 7-Pin Receptacle with Shorting Cap	BLCK = Black	B = Tether
L = Local	1 = 120V	04 = 4000 lm	C5 = Type III	40 = 4000K	E = 7-Pin Receptacle with non-dimming Long Life PE	DKBZ = Dark Bronze	F = Fusing
1 = Single Module	2 = 208V	05 = 5000 lm	D5 = Type IV	50 = 5000K	Note: 0-10V standard	WHTE = White	G = Internal Bubble Level
	3 = 240V	06 = 6000 lm	E5 = Type II Enhanced Back Light				I = Optional IP66 Optical Enclosure
	4 = 277V	07 = 7000 lm					L = Tool-Less Entry
	8 = 120-240V <sup>11</sup>	08 = 8000 lm					R = Enhanced Surge Protection (10kV/5kA)
	5 = 480V	09 = 9000 lm					T = Secondary 20kV/10kA SPD
	D = 347V	10 = 10000 lm					U = DALI Programmable <sup>6,7</sup>
		11 = 11000 lm					V1 = Field Adjustable Module <sup>10, 12</sup>
		12 = 12000 lm					X = Single Pack <sup>8</sup>
	13 = 13000 lm		Y = Coastal Finish <sup>9</sup>				
	14 = 14000 lm		XXX = Special Options				
	15 = 15000 lm						
	16 = 16000 lm						

<sup>1</sup> Fusing requires discrete voltage.

<sup>2</sup> 02 Lumen Level, Voltage options 1, 2, 3 and 8 only

<sup>3</sup> Nominal IES Type and classing subject to typical variation, individual units may differ

<sup>4</sup> Select 2700K or 3000K CCT for IDA approved units

<sup>5</sup> Lead time varies, contact Factory

<sup>6</sup> Compatible with LightGrid

<sup>7</sup> Not available in 347V, 480V or 347-480V for Lumen Output Levels 08-16

<sup>8</sup> Option provides single pack box per fixture. Standard packaging = 23 units per MagnaPak Container

<sup>9</sup> Recommended for installations within 750 feet from coast. Lead time varies, check with factory.

<sup>10</sup> Not available with DALI "U" option

<sup>11</sup> Only available with 02 Lumen Code

<sup>12</sup> Not compatible with 02 Lumen Code

### Suggested HID Replacement

Approximately 2,000-3,000 lumens to replace 50W-70W HPS Cobra-head

Approximately 4,000-5,000 lumens to replace 100W HPS Cobra-head

Approximately 7,000-9,000 lumens to replace 150W HPS Cobra-head

Approximately 9,000-12,000 lumens to replace 200W HPS Cobra-head

Approximately 12,000-16,000 lumens to replace 250W HPS Cobra-head

**Note: actual replacement lumens may vary based upon mounting height, pole spacing, design criteria, etc.**



CUSTOMER NAME \_\_\_\_\_

PROJECT NAME \_\_\_\_\_

DATE \_\_\_\_\_ TYPE \_\_\_\_\_

CATALOG NUMBER \_\_\_\_\_

LUMEN OUTPUT	DIST.	TYPICAL INITIAL LUMENS			WATTAGE		BUG RATINGS		
		5000K/4000K	3000K	2700K	120V 277V	347V 480V	5000K/4000K	3000K	2700K
02	A5	2000	1900	1900	15*	N/A	B1-U0-G1	B1-U0-G1	B1-U0-G1
	B5						B1-U0-G1	B1-U0-G1	B1-U0-G1
	C5						B1-U0-G1	B0-U0-G1	B0-U0-G1
	D5						B0-U0-G1	B0-U0-G1	B0-U0-G1
	E5						B1-U0-G1	B1-U0-G1	B1-U0-G1
03	A5	3000	2900	2800	22	26	B1-U0-G1	B1-U0-G1	B1-U0-G1
	B5						B1-U0-G1	B1-U0-G1	B1-U0-G1
	C5						B1-U0-G1	B1-U0-G1	B1-U0-G1
	D5						B1-U0-G1	B1-U0-G1	B1-U0-G1
	E5						B1-U0-G1	B1-U0-G1	B1-U0-G1
04	A5	4000	3900	3800	29	33	B1-U0-G1	B1-U0-G1	B1-U0-G1
	B5						B1-U0-G1	B1-U0-G1	B1-U0-G1
	C5						B1-U0-G1	B1-U0-G1	B1-U0-G1
	D5						B1-U0-G1	B1-U0-G1	B1-U0-G1
	E5						B1-U0-G1	B1-U0-G1	B1-U0-G1
05	A5	5000	4900	4700	37	39	B1-U0-G1	B1-U0-G1	B1-U0-G1
	B5						B1-U0-G1	B1-U0-G1	B1-U0-G1
	C5						B1-U0-G1	B1-U0-G1	B1-U0-G1
	D5						B1-U0-G1	B1-U0-G1	B1-U0-G1
	E5						B1-U0-G1	B1-U0-G1	B1-U0-G1
06	A5	6000	5800	5700	46	49	B2-U0-G2	B2-U0-G2	B2-U0-G2
	B5						B1-U0-G1	B1-U0-G1	B1-U0-G1
	C5						B1-U0-G2	B1-U0-G2	B1-U0-G2
	D5						B1-U0-G2	B1-U0-G2	B1-U0-G2
	E5						B2-U0-G2	B2-U0-G2	B2-U0-G2
07	A5	7000	6700	6200	50	51	B2-U0-G2	B2-U0-G2	B2-U0-G2
	B5						B1-U0-G2	B1-U0-G2	B1-U0-G1
	C5						B1-U0-G2	B1-U0-G2	B1-U0-G2
	D5						B1-U0-G2	B1-U0-G2	B1-U0-G2
	E5						B2-U0-G2	B2-U0-G2	B2-U0-G2
08	A5	8000	7600	7100	59		B2-U0-G2	B2-U0-G2	B2-U0-G2
	B5						B2-U0-G2	B2-U0-G2	B1-U0-G2
	C5						B1-U0-G2	B1-U0-G2	B1-U0-G2
	D5						B1-U0-G2	B1-U0-G2	B1-U0-G2
	E5						B2-U0-G2	B2-U0-G2	B2-U0-G2
09	A5	9000	8600	8000	68		B2-U0-G2	B2-U0-G2	B2-U0-G2
	B5						B2-U0-G2	B2-U0-G2	B2-U0-G2
	C5						B1-U0-G2	B1-U0-G2	B1-U0-G2
	D5						B1-U0-G2	B1-U0-G2	B1-U0-G2
	E5						B2-U0-G2	B2-U0-G2	B2-U0-G2

NOTE: \* 120-240V only

For additional information on ERL1 IES files, please click one of the following links:

**Shielded**

CUSTOMER NAME \_\_\_\_\_

PROJECT NAME \_\_\_\_\_

DATE \_\_\_\_\_ TYPE \_\_\_\_\_

CATALOG NUMBER \_\_\_\_\_

LUMEN OUTPUT	DIST.	TYPICAL INITIAL LUMENS			WATTAGE		BUG RATINGS		
		5000K/4000K	3000K	2700K	120V 277V	347V 480V	5000K/4000K	3000K	2700K
10	A5	10000	9600	8900	76	B2-U0-G2	B2-U0-G2	B2-U0-G2	
	B5					B2-U0-G2	B2-U0-G2	B2-U0-G2	
	C5					B2-U0-G2	B2-U0-G2	B1-U0-G2	
	D5					B1-U0-G2	B1-U0-G2	B1-U0-G2	
	E5					B3-U0-G3	B2-U0-G2	B2-U0-G2	
11	A5	11000	10500	9700	87	B3-U0-G3	B3-U0-G3	B2-U0-G2	
	B5					B2-U0-G2	B2-U0-G2	B2-U0-G2	
	C5					B2-U0-G2	B2-U0-G2	B2-U0-G2	
	D5					B2-U0-G2	B2-U0-G2	B1-U0-G2	
	E5					B3-U0-G3	B3-U0-G3	B3-U0-G3	
12	A5	12000	11500	11100	93	B3-U0-G3	B3-U0-G3	B3-U0-G3	
	B5					B2-U0-G2	B2-U0-G2	B2-U0-G2	
	C5					B2-U0-G2	B2-U0-G2	B2-U0-G2	
	D5					B2-U0-G2	B2-U0-G2	B2-U0-G2	
	E5					B3-U0-G3	B3-U0-G3	B3-U0-G3	
13	A5	13000	12400	12000	102	B3-U0-G3	B3-U0-G3	B3-U0-G3	
	B5					B2-U0-G2	B2-U0-G2	B2-U0-G2	
	C5					B2-U0-G3	B2-U0-G2	B2-U0-G2	
	D5					B2-U0-G2	B2-U0-G2	B2-U0-G2	
	E5					B3-U0-G3	B3-U0-G3	B3-U0-G3	
14	A5	14000	13400	13000	110	B3-U0-G3	B3-U0-G3	B3-U0-G3	
	B5					B2-U0-G2	B2-U0-G2	B2-U0-G2	
	C5					B2-U0-G3	B2-U0-G3	B2-U0-G3	
	D5					B2-U0-G2	B2-U0-G2	B2-U0-G2	
	E5					B3-U0-G3	B3-U0-G3	B3-U0-G3	
15	A5	15000	14400	13900	121	B3-U0-G3	B3-U0-G3	B3-U0-G3	
	B5					B3-U0-G3	B2-U0-G2	B2-U0-G2	
	C5					B2-U0-G3	B2-U0-G3	B2-U0-G3	
	D5					B2-U0-G2	B2-U0-G2	B2-U0-G2	
	E5					B3-U0-G3	B3-U0-G3	B3-U0-G3	
16	A5	15700	15000	14600	129	B3-U0-G3	B3-U0-G3	B3-U0-G3	
	B5					B3-U0-G3	B3-U0-G3	B2-U0-G2	
	C5					B2-U0-G3	B2-U0-G3	B2-U0-G3	
	D5					B2-U0-G3	B2-U0-G3	B2-U0-G2	
	E5					B3-U0-G3	B3-U0-G3	B3-U0-G3	

For additional information on ERL1 IES files, please click one of the following links:

[Non-Shielded](#)

[Shielded](#)

**ERL1**  
**Type II Narrow**  
  
15700 Lumens  
5000K  
ERL1\_16A550\_\_\_IES

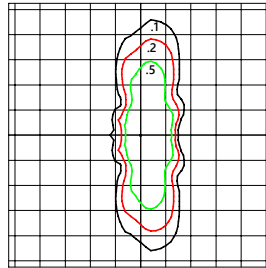

- Mounting Height at 30'
- Initial Footcandle at Grade

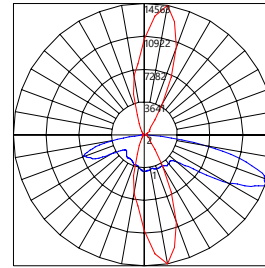

- Vertical plane at max Cd horiz. angle 80°
- Horizontal cone at max Cd vert. angle 68°

**ERL1**  
**Type II Wide**  
  
15700 Lumens  
5000K  
ERL1\_16B550\_\_\_IES

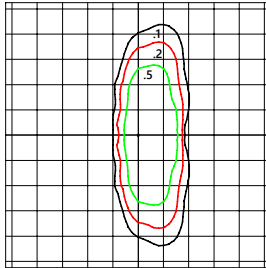

- Mounting Height at 30'
- Initial Footcandle at Grade

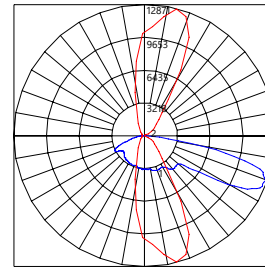

- Vertical plane at max Cd horiz angle 75°
- Horizontal cone at max Cd vert. angle 68°

**ERL1**  
**Type III**  
  
15700 Lumens  
5000K  
ERL1\_16C550\_\_\_IES

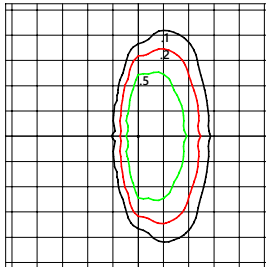

- Mounting Height at 30'
- Initial Footcandle at Grade

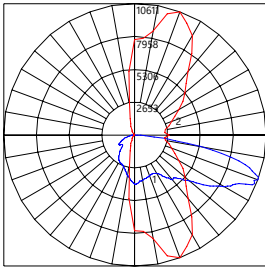

- Vertical plane at max Cd horiz angle 70°
- Horizontal cone at max Cd vert. angle 70°

**ERL1**  
**Type IV Short**  
  
15700 Lumens  
5000K  
ERL1\_16D550\_\_\_IES

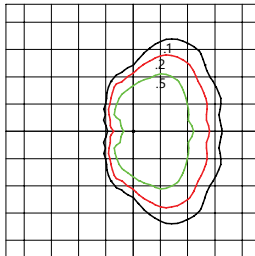

- Mounting Height at 40'
- Initial Footcandle at Grade

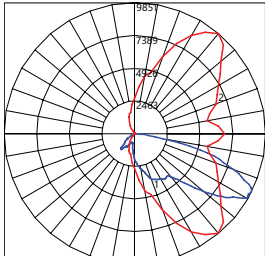

- Vertical plane at max Cd horiz angle 50°
- Horizontal cone at max Cd vert. angle 63°

**ERL1**  
**Type II Medium**  
  
15700 Lumens  
5000K  
ERL1\_16E550\_\_\_IES

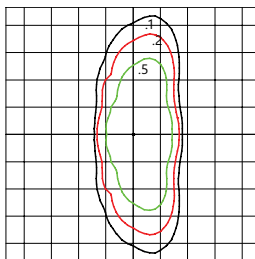

- Mounting Height at 40'
- Initial Footcandle at Grade

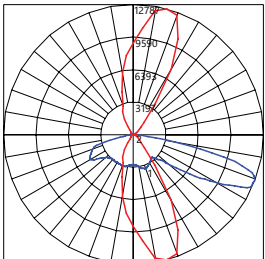

- Vertical plane at max Cd horiz angle 75°
- Horizontal cone at max Cd vert. angle 69°

ISO illuminate diagrams and polar plots are representative of the SKUs illustrated. Refer to IES files for SKU specific information.

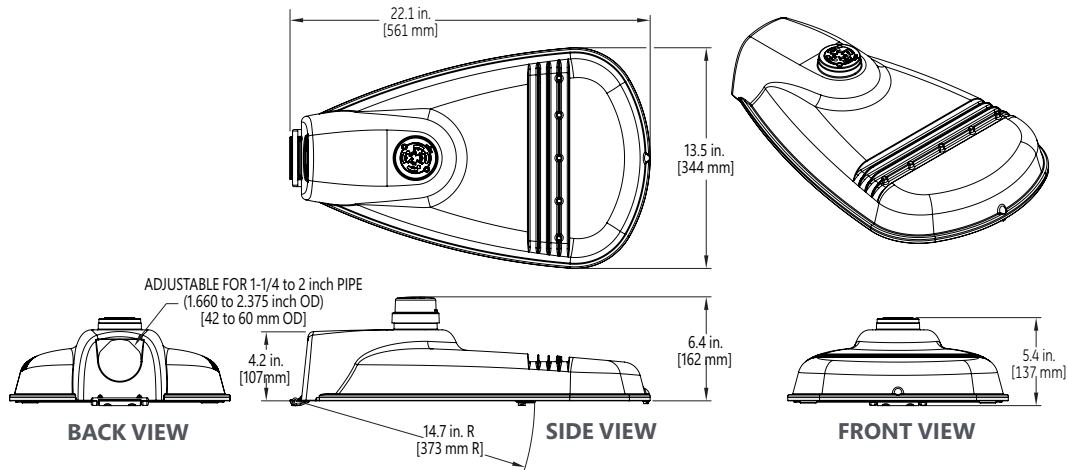

### Mounting

- Adjustable for 1.25 to 2 in. nominal mounting pipe (1.660 to 2.375 inch OD)
- Integral diecast mounting pipe stop
- Slipfitter with +/- 5 degrees of leveling adjustment

### Effective Projected Area

- 0.5 sq ft max (0.046 sq m)

### Weight

- 12.4 lbs (5.6 kgs)

### Accessories

SAP Number	Part Number	Description
93029237G	PED-MV-LED-7	ANSI C136.41 Dimming PE, 120-277V
93029238G	PED-347-LED-7	ANSI C136.41 Dimming PE, 347V
93029239G	PED-480-LED-7	ANSI C136.41 Dimming PE, 480V
28299	PECOTL	Long Life PE 120-277V
93147530	PECHTL	Long Life PE 347-480V
73251	SCCL-PECTL	Shorting Cap

### Network Lighting Controls



Current's **LightGrid™** Outdoor Lighting Control System is designed for Street and Roadway Applications. It enables remote monitoring, control, and asset management of a single fixture or a group of fixtures through a web enabled Central Management System.

CUSTOMER NAME \_\_\_\_\_

PROJECT NAME \_\_\_\_\_

DATE \_\_\_\_\_ TYPE \_\_\_\_\_

CATALOG NUMBER \_\_\_\_\_



The Evolve® LED Roadway ERL2 Luminaire is optimized utilizing advanced LED reflective optical system for local, collector and major roadways. The modern design incorporates the heat sink directly into the unit for heat transfer to prolong LED life.

### Construction

<b>Housing:</b>	Aluminum die cast enclosure. Casting Integral heat sink for maximum heat transfer
<b>Lens:</b>	Impact resistant tempered glass
<b>Paint:</b>	Corrosion resistant polyester powder painted, minimum 2.0 mil thickness (RAL & custom colors available) Standard = Black, Dark Bronze Gray, White Optional = Coastal Finish
<b>Weight:</b>	24.0 lbs (10.9 kgs)

### Optical System

<b>Lumens:</b>	16,000 - 32,000
<b>Distribution:</b>	Type II Narrow, Type II Wide, Type III, Type IV and Type II Enhanced Back light
<b>Efficacy:</b>	112-140 LPW
<b>CCT:</b>	2700K, 3000K, 4000K, 5000K
<b>CRI (Min):</b>	70 CRI

### Electrical

<b>Input Voltage:</b>	120-277V or 347-480V
<b>Input Frequency:</b>	50/60Hz
<b>Power Factor:</b>	≥ 90% at rated watts
<b>Total Harmonic Distortion:</b>	≤ 20% at rated watts

### Surge Protection\*

STANDARD	OPTIONAL
10kV/5kA	Secondary 10kV/5kA (R Option) or Secondary 20kV/10kA (T Option)

\*Per ANSI C136.2-2018

### Lumen Maintenance

Projected Lxx per IES TM-21-11 at 25°C

LUMEN CODES	DISTRIBUTIONS	LXX(10K) @ HOURS		
		25,000 HR	50,000 HR	60,000 HR
16	A5, B5, C5, D5, E5	L99	L99	L99
18	A5, B5, C5, D5, E5	L99	L98	L98
19	A5, B5, C5, D5, E5	L99	L98	L97
21	A5, B5, C5, D5, E5	L94	L87	L85
23	A5, B5, C5, D5, E5	L97	L96	L95
25	A5, B5, C5, D5, E5	L96	L95	L95
27	A5, B5, C5, D5, E5	L96	L94	L94
28	A5, B5, C5, D5, E5	L96	L94	L93
30, 31	A5, B5, C5, D5, E5	L95	L93	L92
32	A5, B5, C5, D5, E5	L94	L91	L90

Note: Projected Lxx based on LM80 (≥ 10,000 hour testing). Accepted industry tolerances apply to initial luminous flux and lumen maintenance measurements.

### Ratings

<b>Operating Temp:</b>	-40°C to 50°C *
<b>Vibration:</b>	3G per ANSI C136.31-2018
<b>LM-79:</b>	Testing in accordance with IES Standards
<b>EMI:</b>	Title 47 CFR Part 15 Class A
<b>RoHS:</b>	Complies with the material restrictions of RoHS

\*ERL2 (32K Lumen 347-480V SKU) operates at -40°C to 45°C

### Controls

<b>Dimming:</b>	Standard-0-10V Optional-DALI (Option U)
<b>Sensors:</b>	Photo Electric Sensors (PE) available LightGrid Compatible

### Warranty

5 Year (Standard)

10 Year (Optional)

Not all product variations listed on this page are DLC qualified. Visit [www.designlights.org/search](http://www.designlights.org/search) to confirm qualifications.



### Ordering Information

## ERL2

PROD. ID	VOLTAGE	LUMENS (LM)	DISTRIBUTION <sup>3</sup>	CCT	CONTROLS PER ANSI C136.41	COLOR	OPTIONS
E = Evolve	0 = 120-277V <sup>1</sup>	16 = 16,000 lm	A5 = Type II Narrow	27 = 2700K <sup>2</sup>	A = 7-Pin Receptacle	GRAY = Gray	A = 4 Bolt Slipfitter <sup>4</sup>
R = Roadway	H = 347-480V <sup>1</sup>	18 = 18,000 lm	B5 = Type II Wide	30 = 3000K <sup>2</sup>	D = 7-Pin Receptacle with Shorting Cap	BLCK = Black	B = Tether
L = Local	1 = 120V	19 = 19,000 lm	C5 = Type III	40 = 4000K	E = 7-Pin Receptacle with non-Dimming Long Life PE <sup>5</sup>	DKBZ = Dark Bronze	F = Fusing
2 = Double Module	2 = 208V	21 = 21,000 lm	D5 = Type IV <sup>6</sup>	50 = 5000K	Note: 0-10V control standard unless DALI Option "U" requested	WHITE = White	G = Internal Bubble Level
	3 = 240V	23 = 23,000 lm	E5 = Type II Enhanced Back Light				I = Optional IP66 Optical Enclosure
	4 = 277V	25 = 25,000 lm					L = Tool-Less Entry
	D = 347V	27 = 27,000 lm					R = Secondary 10kV/5kA SPD
	5 = 480V	28 = 28,000 lm					T = Secondary 20kV/10kA SPD <sup>1</sup>
		30 = 30,000 lm					U = DALI Programmable <sup>6,7</sup>
		31 = 31,000 lm					V1 = Field Adjustable Module <sup>9</sup>
	32 = 32,000 lm	Y = Coastal Finish <sup>8</sup>					
		XXX = Special Options					

- <sup>1</sup> Not Available with Fusing
- <sup>2</sup> Select 2700K or 3000K CCT for IDA approved units
- <sup>3</sup> Nominal IES Type classing subject to typical variation, individual units may differ
- <sup>4</sup> Lead time varies, contact Factory
- <sup>5</sup> Per ANSI C136.10-2017
- <sup>6</sup> Compatible with LightGrid
- <sup>7</sup> Not available in 347V, 480V or 347-480V
- <sup>8</sup> Recommended for installations within 750 feet from coast. Lead time varies, check with factory.
- <sup>9</sup> Not available with DALI "U" option
- <sup>10</sup> Forward throw distribution. Classifies as Type III for lumen codes 23-32. Review IES curve for application.

### Suggested HID Replacement

Approximately 21,500 -32,000 lumens to replace 400W HPS  
Cobra-head

Note: actual replacement lumens may vary based upon mounting height, pole spacing, design criteria, etc.

CUSTOMER NAME \_\_\_\_\_

PROJECT NAME \_\_\_\_\_

DATE \_\_\_\_\_ TYPE \_\_\_\_\_

CATALOG NUMBER \_\_\_\_\_

LUMEN OUTPUT	DIST.	TYPICAL INITIAL LUMENS			WATTAGE		BUG RATINGS		
		5000K/ 4000K	3000K	2700K	120V 277V	347V 480V	5000K/4000K	3000K	2700K
16	A5	16000	15300	14200	114	B3-U0-G3	B3-U0-G3	B3-U0-G3	
	B5					B3-U0-G3	B3-U0-G3	B2-U0-G2	
	C5					B2-U0-G3	B2-U0-G3	B2-U0-G3	
	D5					B2-U0-G3	B2-U0-G3	B2-U0-G2	
	E5					B3-U0-G3	B3-U0-G3	B3-U0-G3	
18	A5	18000	17200	16000	130	B3-U0-G3	B3-U0-G3	B3-U0-G3	
	B5					B3-U0-G3	B3-U0-G3	B3-U0-G3	
	C5					B3-U0-G3	B2-U0-G3	B2-U0-G3	
	D5					B2-U0-G3	B2-U0-G3	B2-U0-G3	
	E5					B3-U0-G3	B3-U0-G3	B3-U0-G3	
19	A5	19000	18200	16900	140	B3-U0-G3	B3-U0-G3	B3-U0-G3	
	B5					B3-U0-G3	B3-U0-G3	B3-U0-G3	
	C5					B3-U0-G3	B3-U0-G3	B2-U0-G3	
	D5					B2-U0-G3	B2-U0-G3	B2-U0-G3	
	E5					B3-U0-G3	B3-U0-G3	B3-U0-G3	
21	A5	21000	20100	18600	160	B3-U0-G3	B3-U0-G3	B3-U0-G3	
	B5					B3-U0-G3	B3-U0-G3	B3-U0-G3	
	C5					B3-U0-G3	B3-U0-G3	B3-U0-G3	
	D5					B2-U0-G3	B2-U0-G3	B2-U0-G3	
	E5					B3-U0-G3	B3-U0-G3	B3-U0-G3	
23	A5	23000	22000	21300	177	B3-U0-G3	B3-U0-G3	B3-U0-G3	
	B5					B3-U0-G3	B3-U0-G3	B3-U0-G3	
	C5					B3-U0-G4	B3-U0-G4	B3-U0-G3	
	D5					B2-U0-G3	B2-U0-G3	B2-U0-G3	
	E5					B3-U0-G3	B3-U0-G3	B3-U0-G3	
25	A5	25000	24000	23200	191	B3-U0-G3	B3-U0-G3	B3-U0-G3	
	B5					B3-U0-G3	B3-U0-G3	B3-U0-G3	
	C5					B3-U0-G4	B3-U0-G4	B3-U0-G4	
	D5					B2-U0-G4	B2-U0-G4	B2-U0-G3	
	E5					B4-U0-G4	B4-U0-G4	B4-U0-G4	

For additional information on ERL2 IES files, please click one of the following links:

CUSTOMER NAME \_\_\_\_\_

PROJECT NAME \_\_\_\_\_

DATE \_\_\_\_\_ TYPE \_\_\_\_\_

CATALOG NUMBER \_\_\_\_\_

LUMEN OUTPUT	DIST.	TYPICAL INITIAL LUMENS			WATTAGE		BUG RATINGS		
		5000K/4000K	3000K	2700K	120V 277V	347V 480V	5000K/4000K	3000K	2700K
27	A5	27000	25900	25100	212		B4-U0-G4	B4-U0-G4	B3-U0-G3
	B5						B3-U0-G3	B3-U0-G3	B3-U0-G3
	C5						B3-U0-G4	B3-U0-G4	B3-U0-G4
	D5						B2-U0-G4	B2-U0-G4	B2-U0-G4
	E5						B4-U0-G4	B4-U0-G4	B4-U0-G4
28	A5	28000	26800	26000	223		B4-U0-G4	B4-U0-G4	B4-U0-G4
	B5						B3-U0-G4	B3-U0-G3	B3-U0-G3
	C5						B3-U0-G4	B3-U0-G4	B3-U0-G4
	D5						B3-U0-G4	B3-U0-G4	B2-U0-G4
	E5						B4-U0-G4	B4-U0-G4	B4-U0-G4
30	A5	30000	28800	27900	242		B4-U0-G4	B4-U0-G4	B4-U0-G4
	B5						B3-U0-G4	B3-U0-G4	B3-U0-G4
	C5						B3-U0-G4	B3-U0-G4	B3-U0-G4
	D5						B3-U0-G4	B3-U0-G4	B3-U0-G4
	E5						B4-U0-G4	B4-U0-G4	B4-U0-G4
31	A5	31000	29700	28800	252		B4-U0-G4	B4-U0-G4	B4-U0-G4
	B5						B3-U0-G4	B3-U0-G4	B3-U0-G4
	C5						B3-U0-G4	B3-U0-G4	B3-U0-G4
	D5						B3-U0-G4	B3-U0-G4	B3-U0-G4
	E5						B4-U0-G4	B4-U0-G4	B4-U0-G4
32	A5	32000	30700	29700	265		B4-U0-G4	B4-U0-G4	B4-U0-G4
	B5						B3-U0-G4	B3-U0-G4	B3-U0-G4
	C5						B3-U0-G4	B3-U0-G4	B3-U0-G4
	D5						B3-U0-G4	B3-U0-G4	B3-U0-G4
	E5						B4-U0-G4	B4-U0-G4	B4-U0-G4

For additional information on ERL2 IES files, please click one of the following links:



**ERL2**  
**Type II Narrow**

32,000 Lumens  
5000K  
ERL2\_32A550\_...IES

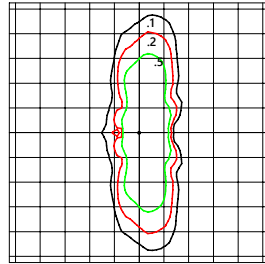

- Mounting Height at 30'
- Initial Footcandle at Grade

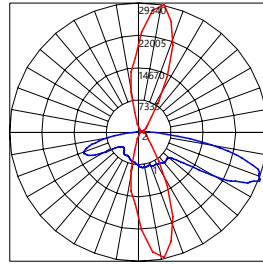

- Vertical plane at max Cd horiz. angle 80°
- Horizontal cone at max Cd vert. angle 68°

**ERL2**  
**Type II Wide**

32,000 Lumens  
5000K  
ERL2\_32B550\_...IES

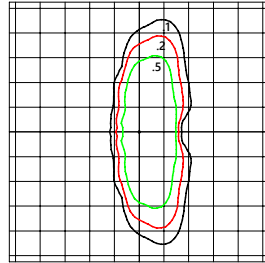

- Mounting Height at 30'
- Initial Footcandle at Grade

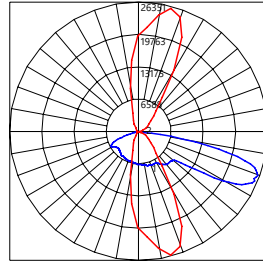

- Vertical plane at max Cd horiz. angle 75°
- Horizontal cone at max Cd vert. angle 70°

**ERL2**  
**Type III**

32,000 Lumens  
5000K  
ERL2\_32C550\_...IES

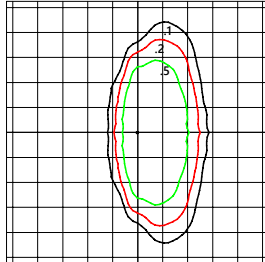

- Mounting Height at 30'
- Initial Footcandle at Grade

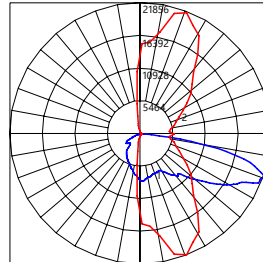

- Vertical plane at max Cd horiz. angle 70°
- Horizontal cone at max Cd vert. angle 70°

**ERL2**  
**Type III (FWT)**

32,000 Lumens  
5000K  
ERL2\_32D550\_...IES  
Forward Throw

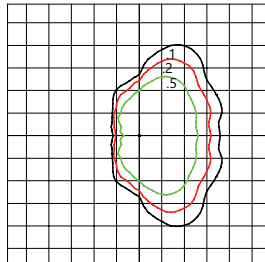

- Mounting Height at 30'
- Initial Footcandle at Grade

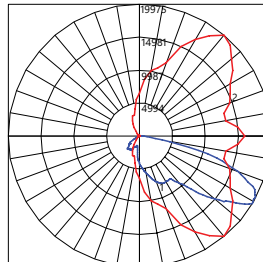

- Vertical plane at max Cd horiz. angle 50°
- Horizontal cone at max Cd vert. angle 59°

**ERL2**  
**Type II Medium**

32,000 Lumens  
5000K  
ERL2\_32E550\_...IES

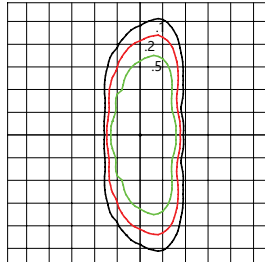

- Mounting Height at 30'
- Initial Footcandle at Grade

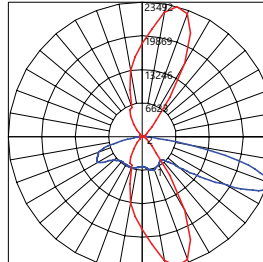

- Vertical plane at max Cd horiz. angle 75°
- Horizontal cone at max Cd vert. angle 67°

ISO illuminate diagrams and polar plots are representative of the SKUs illustrated.  
Refer to IES files for SKU specific information.

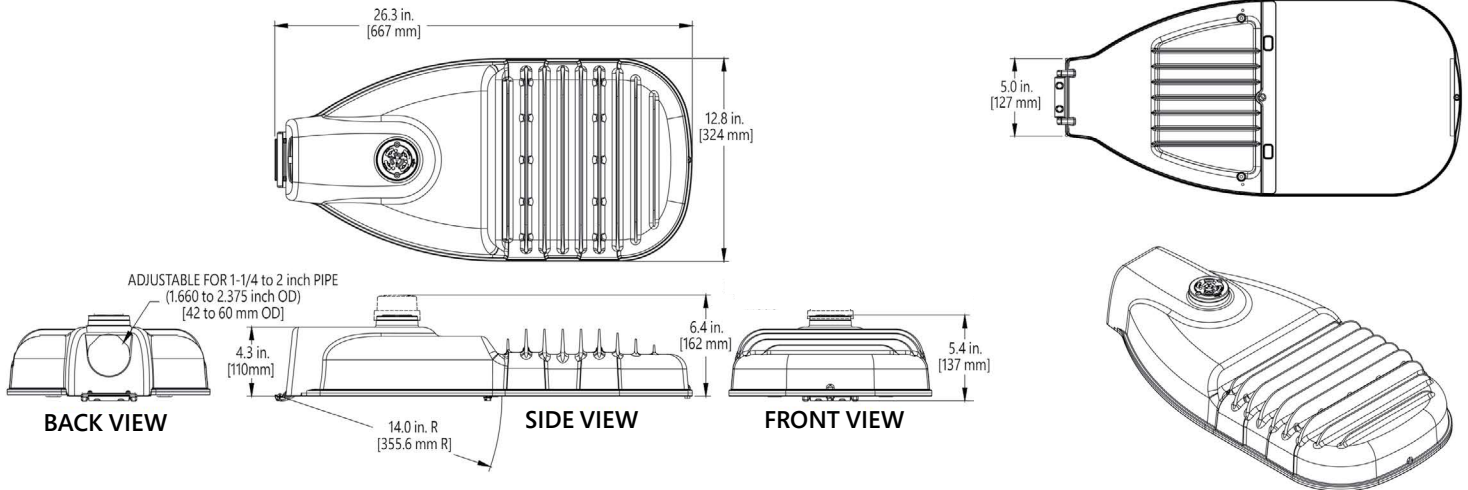

### Mounting

- Adjustable for 1.25 to 2 in. nominal mounting pipe (1.660 to 2.375 inch OD)
- Integral diecast mounting pipe stop
- Slipfitter with +/- 5 degrees of leveling adjustment

### Effective Projected Area

- 0.57 sq ft max (0.053 sq m)

### Weight

- 24.0 lbs (10.9 kgs)

### Accessories

SAP NUMBER	PART NUMBER	DESCRIPTION
93029237G	PED-MV-LED-7	ANSI C136.41 Dimming PE, 120-277V
93029238G	PED-347-LED-7	ANSI C136.41 Dimming PE, 347V
93029239G	PED-480-LED-7	ANSI C136.41 Dimming PE, 480V
28299	PEC0TL	Long Life PE 120-277V
93147530	PECHTL	Long Life PE 347-480V
73251	SCCL-PECTL	Shorting Cap

### Network Lighting Controls



Current's LightGrid™ Outdoor Lighting Control System is designed for Street and Roadway Applications. It enables remote monitoring, control, and asset management of a single fixture or a group of fixtures through a web enabled Central Management System.

### HOUSE SIDE SHIELDS

#### ERLC Shields

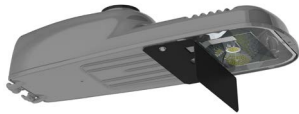
Product Code:	93110037G	Description:	ELSHS-ERLC-BLCK
Product Code:	93110038G	Description:	ELSHS-ERLC-GRAY
			

#### ERL1 Shields

Product Code:	93024487G	Description:	ELSHS-ERL1-BLCK
Product Code:	93046386G	Description:	ELSHS-ERL1-GRAY
Product Code:	93068998	Description:	ELSHS-ERL1-DKBZ
			

#### ERL2 Shields

Product Code:	93070722	Description:	ELSHS-ERL2-BLCK
Product Code:	93085564G	Description:	ELSHS-ERL2-GRAY
Product Code:	93096747G	Description:	ELSHS-ERL2-DKBZ
			

### STREET SIDE SHIELDS

#### ERLC Shields

Product Code:	93132372	Description:	ELSFS-ERLC-BLCK-10
Product Code:	93132373	Description:	ELSFS-ERLC-BLCK-15
Product Code:	93134760	Description:	ELSFS-ERLC-BLCK-20
			

#### ERL1 Shields

Product Code:	93092595	Description:	ELSFS-ERL1-BLCK-10
Product Code:	93108740G	Description:	ELSFS-ERL1-GRAY-10
Product Code:	93092906	Description:	ELSFS-ERL1-BLCK-15
Product Code:	93105144G	Description:	ELSFS-ERL1-GRAY-15
Product Code:	93088130	Description:	ELSFS-ERL1-BLCK-20
Product Code:	93088131G	Description:	ELSFS-ERL1-GRAY-20
			

#### ERL2 Shields

Product Code:	93132955G	Description:	ELSFS-ERL2-BLCK-20
Product Code:	93132986G	Description:	ELSFS-ERL2-GRAY-20
			

## SIDE SHIELDS (L&R)

Shipped as a kit - L & R can be used independently

### ERLC Shields

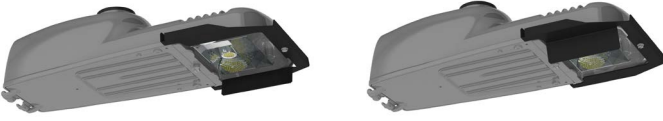
Product Code:	93132374G	Description:	ELS-ERLC-LEFTRIGHTSIDEKIT-BLCK-10
			

### ERL1 SHIELDS

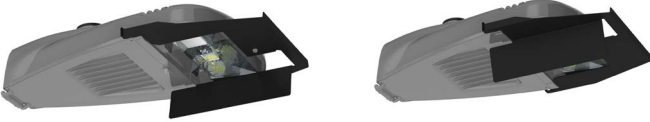
Product Code:	93118695G	Description:	ELS-ERL1H-LEFTRIGHTSIDEKIT-BLCK-10
			

### ERL2 SHIELDS

Product Code:	93132989G	Description:	ELS-ERL2-LEFTRIGHTSIDEKIT-BLCK-10
			

**FOOTNOTES:**

- 1) 10 = 1" Shield Depth; 15 = 1.5" Shield Depth; 20 = 2" Shield Depth
- 2) Black is recommended to reduce potential for glare coming off of the shield
- 3) Use "House Side" Shield to block light trespass behind the pole
- 4) Use "Street Side" / Front Shield to block light light trespass across the street